

Handbook

for

Palm™ m100 Series Handhelds

Copyright

Copyright © 1998-2001 Palm, Inc. All rights reserved. Graffiti, HotSync, PalmConnect, PalmModem and Palm OS are registered trademarks, and the HotSync logo, Palm, and the Palm logo are trademarks of Palm, Inc. Other product and brand names may be trademarks or registered trademarks of their respective owners.

Disclaimer and Limitation of Liability

Palm, Inc. and its subsidiaries assume no responsibility for any damage or loss resulting from the use of this handbook.

Palm, Inc. and its subsidiaries assume no responsibility for any loss or claims by third parties which may arise through the use of this software. Palm, Inc. and its subsidiaries assume no responsibility for any damage or loss caused by deletion of data as a result of malfunction, dead battery, or repairs. Be sure to make backup copies of all important data on other media to protect against data loss.

Important: Please read the End User Software License Agreement with this product before using the accompanying software program(s). Using any part of the software indicates that you accept the terms of the End User Software License Agreement.

HotSync® Cradle and Adapters and Software Download Available

The HotSync® cradle/cable supplied with your handheld fits a USB connector. If you do not have a USB port available on your computer, you can order a 9-pin serial cradle and the following types of adapters: 25-pin serial adapter (for use with Windows computers), or a Macintosh serial adapter. To order a HotSync cradle or adapters, go to the web site: <http://www.palm.com>.

Palm™ Desktop software is supplied on a CD-ROM disc. If you do not have access to a CD-ROM drive for your computer, you can download the Palm Desktop software from <http://www.palm.com>.

P/N: 406-3352A-US

Contents

About This Book	1
Chapter 1: Introduction to Your Handheld	3
Getting to know your Palm m100 series handheld	3
What is a Palm m100 series handheld?.....	3
System requirements	4
Palm m100 series components	5
Upgrading from another Palm OS handheld	8
Preparing to use your handheld	8
Using the protective flip cover	9
Changing the face plate	10
Installing the batteries	11
Palm Desktop software	12
Using your handheld with another PIM	16
Tapping and typing	16
Tap with the stylus to get things done.....	16
Elements of the handheld interface	17
Opening applications	19
Using menus	20
Entering data.....	22
Customizing your handheld.....	26
Chapter 2: Entering Data in Your Handheld	29
Using Graffiti writing to enter data	29
Writing Graffiti characters	29
Graffiti tips	31
The Graffiti alphabet.....	32
Writing capital letters	33
Writing numbers	33
Graffiti numbers	34
Writing punctuation marks	34
Additional Graffiti punctuation.....	35
Writing symbols and extended characters	35
Writing accented characters	35
Accent strokes.....	36

Additional non-English characters	36
Navigation strokes.....	36
Graffiti ShortCuts	37
Using the onscreen keyboard.....	38
Using Note Pad	38
Using your computer keyboard.....	39
Importing data.....	39
Importing data from a Windows computer	39
Importing data from a Macintosh	40

Chapter 3: Managing Your Applications..... 43

Using the Applications Launcher	43
Selecting applications.....	43
Switching between applications.....	43
Categorizing applications.....	43
Changing the Applications Launcher display.....	44
Choosing preferences.....	45
Installing and removing applications	46
Installing add-on applications	46
Removing applications	50
Removing Palm Desktop software.....	51
Security.....	52
Assigning a password.....	52
Changing or deleting a password	53
Locking your handheld	54
Recovering from a forgotten password.....	57

Chapter 4: Using Expansion Features 59

Inserting an expansion card	59
Removing an expansion card.....	60
Opening expansion card applications	60
Switching between your handheld and an expansion card	61
Copying applications to an expansion card.....	61
Deleting applications from an expansion card.....	62
Card Info	63
Reviewing card information	63
Renaming a card	64
Formatting a card	64
Card Info menus	64

Chapter 5: Using Your Basic Applications	67
Overview of basic applications	67
Date Book	67
Address Book.....	68
To Do List.....	69
Note Pad.....	70
Memo Pad	71
Calculator	71
Clock	72
Common tasks	72
Creating records.....	72
Editing records.....	73
Deleting records.....	75
Purging records.....	76
Exchanging and updating data: HotSync operations.....	77
Beaming information.....	82
Categorizing records.....	84
Finding information.....	88
Sorting lists of records.....	91
Making records private.....	93
Attaching notes.....	96
Choosing fonts.....	96
Reviewing Reminders.....	98
Application-specific tasks	99
Date Book	99
Address Book.....	113
To Do List.....	119
Note Pad.....	124
Memo Pad	128
Calculator	130
Clock	132
Chapter 6: Advanced HotSync® Operations.....	135
Selecting HotSync setup options.....	135
Customizing HotSync application settings	141
IR HotSync operations.....	143
Preparing your computer for infrared communication	144
Configuring HotSync Manager for infrared communication.....	144
Performing an IR HotSync operation.....	146
Returning to cradle/cable HotSync operations.....	147
Conducting a HotSync operation via modem.....	148
Preparing your computer	148
Preparing your handheld.....	151

Selecting the conduits for a modem HotSync operation	152
Performing a HotSync operation via a modem.....	153
Using File Link	153
Creating a user profile.....	153

Chapter 7: Setting Preferences for Your Handheld 157

Viewing preferences.....	157
Buttons preferences	158
Pen preferences	159
HotSync buttons preferences	160
Digitizer preferences	161
Formats preferences	161
Country default.....	161
Time, date, week start, and numbers formats	162
General preferences	162
Auto-off delay	162
System, alarm, and game sounds.....	163
Beam Receive.....	163
Date and Time preferences.....	164
Connection preferences.....	164
Editing connections.....	165
Network preferences and TCP/IP software	166
Selecting a service.....	167
Entering a user name	167
Entering a password	168
Selecting a connection.....	168
Adding telephone settings	169
Connecting to your service.....	171
Creating additional service templates.....	172
Adding detailed information to a service template.....	172
Login scripts	175
Creating a login script on your handheld.....	176
Plug-in applications	178
Deleting a service template	178
Network preferences menu commands	178
TCP/IP troubleshooting	179
Owner preferences.....	180
ShortCuts preferences	181
Creating a ShortCut.....	181
Editing a ShortCut.....	182
Deleting a ShortCut.....	182

Appendix A: Maintaining Your Handheld	183
Caring for your handheld	183
Battery considerations	184
Resetting your handheld	185
Performing a soft reset	185
Performing a hard reset.....	186
Appendix B: Frequently Asked Questions	191
Software installation problems.....	192
Operating problems	193
Tapping and writing problems	195
Application problems	196
HotSync problems	197
Beaming problems.....	205
Password problems.....	206
Technical support.....	207
Appendix C: Non-ASCII Characters for Login Scripts	209
Use of ^char	209
Carriage return and line feed	209
Literal characters	209
Product Regulatory Information.....	211
Index.....	215

About This Book

Welcome to the Palm™ m100 series handheld. This handbook is designed to help you get up and running quickly on your handheld. It describes all you need to know about how to use your handheld and the applications that come with it.

It walks you through:

- Locating all the parts of your handheld
- Viewing and entering data
- Working with expansion cards
- Using your handheld with your computer
- Personalizing your handheld with your own preference settings

After you become familiar with the basic functionality of your handheld, you can use the rest of this handbook as a reference for less common tasks, for maintaining your handheld, and also as a source of information if you have problems operating it.

Chapter 1

Introduction to Your Handheld

This chapter explains the physical buttons and controls on your Palm™ m100 series handheld, how to use your handheld for the first time, how to add expansion cards to your handheld, and how to use HotSync® technology to synchronize your handheld and Palm™ Desktop software.

Getting to know your Palm m100 series handheld

What is a Palm m100 series handheld?

Palm m100 series handhelds will help you stay organized and on time, and keep up with daily tasks while you are away from your desk. Use your new handheld to do the following:

- Enter your schedule in Date Book
- Keep all your contact names, addresses, and phone numbers in Address Book
- Prioritize and assign your tasks a due date in To Do List
- Jot quick notes directly on the screen in Note Pad
- Set alarms from Clock, Date Book, and Note Pad, to keep yourself on schedule and remind yourself of appointments and notes
- Synchronize your data with Palm Desktop software on your Windows or Macintosh computer so you always have a copy
- Insert MultiMediaCard (MMC) or Secure Digital (SD) cards to add additional software or memory, or to back up your data
- Attach and use peripheral hardware devices, such as a modem
- Beam information to another Palm OS® handheld that is close by and has an IR (infrared) port

System requirements

To install and operate Palm Desktop software, your computer system must meet the following requirements:

Minimum requirements: Windows

- IBM-compatible Pentium-class computer
- Windows 98/Me/2000 (Windows 95/NT operating systems require a serial cradle/cable, sold separately)
- 16 MB RAM (64 MB recommended with Windows 2000)
- 30 MB available hard disk space
- VGA monitor or better (the *Quick Tour* requires 256-color video display; for best results, use High Color:16 bit)
- CD-ROM drive (you can also download the Palm Desktop software from <http://www.palm.com>)
- Mouse
- One USB port or available serial port (serial cradle/cable sold separately)

Minimum requirements: Macintosh

- Apple Macintosh or compatible with a Power PC processor
- Mac OS 8.5.1 to 9
- One USB port or available serial port (serial cradle/cable and adapters sold separately)
- 25 MB available hard disk space
- 6 MB free RAM

Optional equipment

- Modem (such as an add-on modem accessory)
- Printer (compatible with your computer and its operating system)
- Infrared communication device
- MultiMediaCard (MMC) or Secure Digital (SD) expansion cards (sold separately)
- HotSync cable, which enables you to perform HotSync operations without your cradle (sold separately, available with either a USB or serial connector)

Palm m100 series components

Locating front panel controls

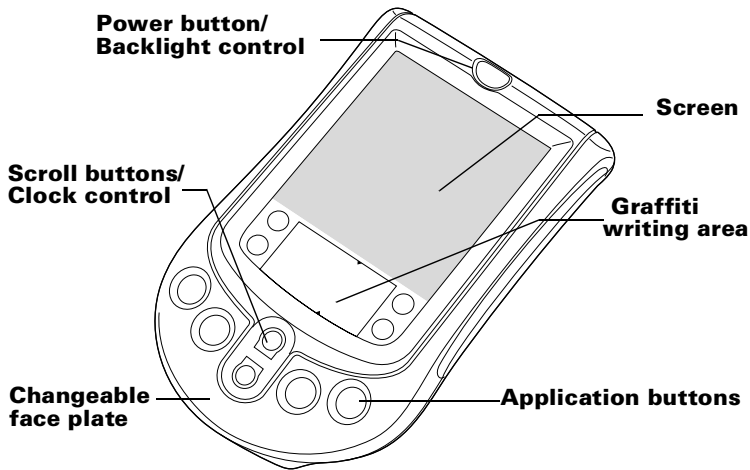

Power button/ Backlight control

Turns your handheld on or off and controls the backlight feature. If your handheld is turned off, pressing the power button turns the unit on and returns you to the last screen you viewed.

If your handheld is turned on, pressing the power button turns the unit off. Pressing the power button for about two seconds turns the backlight on or off.

Screen

Displays the applications and information stored in your handheld. It is touch-sensitive and responds to the stylus.

Graffiti[®] writing area

The area where you write letters and numbers using the Graffiti[®] alphabet. See Chapter 2 to learn how to write Graffiti characters.

Application buttons Activates the individual handheld applications that correspond to the icons on the buttons: Date Book, Address Book, To Do List, and Note Pad. If your handheld is turned off, pressing any application button activates the handheld and opens the corresponding application. This is the fastest way to open an application.

Tip: See “Buttons preferences” in Chapter 7 for details on reassigning these buttons to activate any application on your handheld.

Scroll buttons/ Displays text and other information that extends beyond the handheld screen area.

Clock control When your handheld is on, pressing the lower button scrolls down to view information below the viewing area, and pressing the upper button scrolls up to view information above the viewing area.

When your handheld is off, pressing the top button displays the time. Holding down the top button for a few seconds turns on the backlight so you can see the time if lighting conditions are poor.

Changeable face plate Protects your handheld and enables you to personalize your handheld’s appearance.

Using the backlight

If lighting conditions make it difficult for you to see the information on your handheld, you can use the backlight to illuminate your screen.

To activate the backlight:

- Press the power button and hold it down for about two seconds. Release the button when the backlight turns on.

Tip: In addition, you can assign the full-screen pen stroke to activate the backlight. See “Pen preferences” in Chapter 7 for details.

To turn off the backlight:

- Press and hold the power button for about two seconds. The backlight also turns off automatically (after a period of inactivity) with the Auto-off feature. See “Auto-off delay” in Chapter 7 for more information.

Locating back panel components

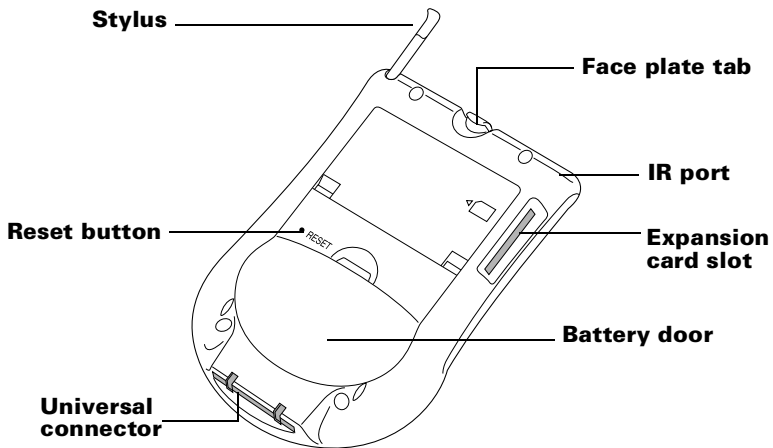

- Stylus** Serves as a pointing and writing device for navigating through applications and entering data on your handheld. To use the stylus, slide it out of the storage slot and hold it as you would a pen or pencil.
- Face plate tab** Releases the face plate so you can personalize the appearance of your handheld with another face plate (sold separately).
- IR port** Uses infrared technology to transmit data to and receive data from other Palm OS handhelds, and to perform HotSync operations. See “Common tasks” in Chapter 5 and “IR HotSync operations” in Chapter 7 for more information.
- Expansion card slot** Accepts MultiMediaCard (MMC) or Secure Digital (SD) expansion cards, enabling you to add more memory or applications. You can also back up data to an expansion card.
- Battery door** Secures the batteries that power your handheld.
- Reset button** Under normal use, you should not have to use the reset button. See Appendix A for information about when and how to use the reset button.

Universal connector

Connects your handheld to the cradle/cable, which in turn connects to the back of your computer. This allows you to update the information between your handheld and computer using HotSync technology.

The universal connector also connects peripheral hardware devices, such as a modem, to your handheld.

Upgrading from another Palm OS handheld

If you already own a Palm OS handheld, you must install the version of Palm Desktop software that comes with your new handheld. To upgrade quickly and easily, perform the tasks described in the following sections. Some tasks are specifically for upgrading.

Preparing to use your handheld

Before you begin using your handheld and Palm Desktop software, you must complete a few easy installation tasks.

To use your handheld and Palm Desktop software, complete the following:

- (If upgrading) Perform a HotSync operation using your old handheld and cradle/cable. This ensures all data on your handheld is on your desktop computer.
- Connect the HotSync cradle/cable that comes with your Palm m100 series handheld to your computer. See “Connecting the HotSync cradle/cable” later in this chapter for details.
- (If upgrading) You may want to create a copy of your old Palm Desktop software folder and its contents before installing your new Palm Desktop software. If you do this, rename the copied folder (for example, Palm Old), and store it outside the Palm Desktop software folder. This step is optional.
- Install the Palm Desktop software that comes with your Palm m100 series handheld. See “Installing Palm Desktop software” later in this chapter for details.

- Perform a HotSync operation. See “Exchanging and updating data: HotSync operations” in Chapter 5 for details.
- (If upgrading) Rename your old handheld. To prevent unexpected results during HotSync operations, each handheld must have a unique name. We recommend that you perform a hard reset on your old handheld. See “Performing a hard reset” in Appendix A for details.

Using the protective flip cover

The flip cover protects your handheld screen when it is not in use. The window in the cover enables you to quickly view the time and alarm reminder messages when your handheld cover is closed. To view the time, press the top scroll button which is accessible through the hole at the bottom of the cover.

You can open the cover so that it rests on the back of your handheld, or remove it altogether.

To remove the cover:

1. Open the cover and grasp the hinge with your thumb.
2. Gently rock the cover from one side to the other until the hinge prongs release from the slots on the top edge of your handheld.

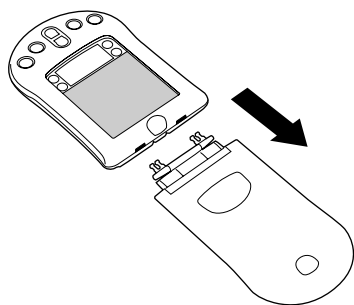

To reattach the cover:

- Align the hinge prongs with the slots on the top edge of your handheld, and then insert one prong at a time until the prongs lock inside the slots.

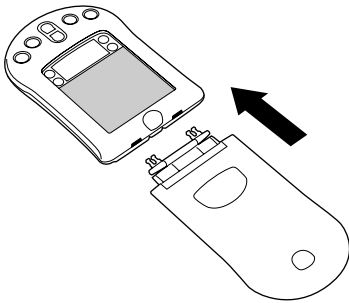

Changing the face plate

You can personalize the appearance of your handheld by changing the face plate. For information about face plate accessories, visit the web site <http://www.palm.com>.

To remove the face plate:

1. Remove the flip cover.
2. Lift the face plate tab slightly to separate it from your handheld and pull the existing face plate away from your handheld.

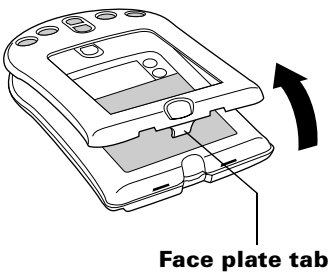

To attach the face plate:

1. Align the bottom edge of the new face plate with the slot on the bottom edge of your handheld.



2. Gently press the top of the face plate onto your handheld until it clicks into position.

Installing the batteries

To use your handheld, you must install two AAA alkaline batteries. The batteries fit behind the battery door on the back of the handheld. See "Battery considerations" in Appendix A for more information.

To install the batteries:

1. Press the latch on the battery door and lift the battery door away from your handheld.

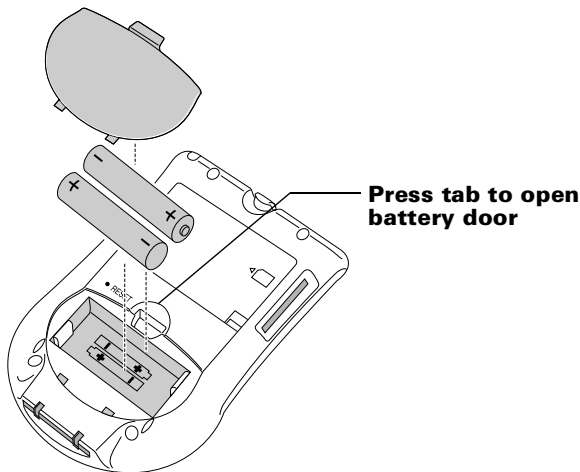

2. Install the two AAA alkaline batteries supplied with your handheld into the battery compartment.

Note: A diagram in the interior of the battery compartment shows + and - ends of the batteries. When correctly installed, the clips in the battery compartment secure the batteries in place.

3. Insert the battery door back into place so that it is flush with the back of your handheld and “clicks” into position.

Important: Do not force the battery door. When the batteries are correctly installed, the battery door clips smoothly into place. If you feel resistance when replacing the door, make sure the door is aligned with the slots on the back of your handheld, and that the batteries are firmly seated in the battery compartment.

Palm Desktop software

Palm Desktop software extends many of the functions of your handheld to your computer and serves to back up all your data. Viewing and editing your data using Palm Desktop software is optional. However, when you use it with your handheld and the built-in HotSync technology, you can fully synchronize the information on your handheld with the information on your computer.

It is a good idea to back up your data in case something happens to the data on your handheld. Changes you make on your handheld or Palm Desktop software appear in both places after you synchronize.

With Palm Desktop software, you can do the following:

- Work with your handheld applications on your computer. Palm Desktop software duplicates the Date Book, Address Book, To Do List, and Memo Pad applications on your handheld, so you can view, enter, and modify any data stored on your handheld. (You cannot modify Note Pad data in Palm Desktop software.)
- Back up the data stored on your handheld with HotSync technology and synchronize the data on your Palm Desktop software. Synchronization is a one-step procedure that ensures your data is always safe and up-to-date. See “Exchanging and updating data: HotSync operations” in Chapter 5 for more information.

- Import and export data, so you can easily transfer data from other desktop applications into Date Book, Address Book, To Do List, and Memo Pad. See “Importing data” in Chapter 2 for more information.
- Print your Date Book, Address Book, To Do List, and Memo Pad information on any printer.

Connecting the HotSync cradle/cable

Important: The HotSync cradle/cable supplied with your handheld fits a USB connector. If your computer does not have a USB port, or if you are using Windows 95, Windows NT, or an older Macintosh, you can order a serial cradle/cable and a 25-pin serial adapter, if necessary, from <http://www.palm.com>. Follow the documentation that accompanies the serial cradle/cable before attempting to complete the installation tasks.

1. Shut down and turn off your computer.
2. Plug the USB connector on the cradle/cable into a USB port on your computer.
3. If you are using a cable, plug the other end into the universal connector on the handheld.

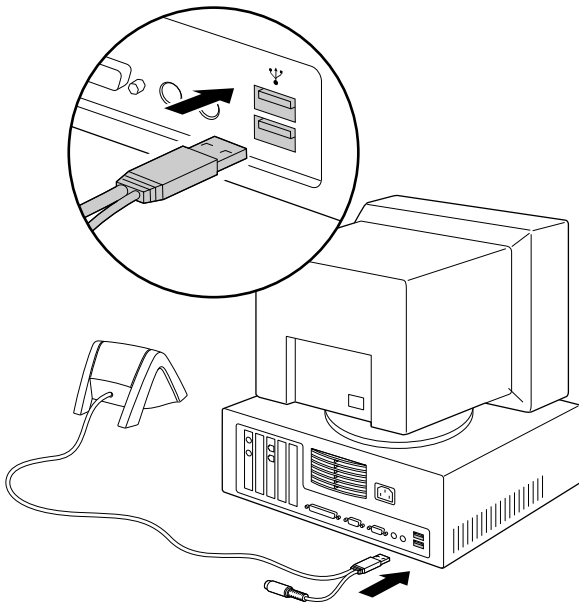

Installing Palm Desktop software

The following instructions guide you through installing Palm Desktop software. After installation, refer to the online Help in Palm Desktop software, the *Quick Tour* in Palm Desktop software (for Windows users), and the *Palm Desktop Software for the Macintosh User's Guide* located in the Documentation folder in the Palm Desktop folder.

To ensure a safe and uninterrupted installation of Palm Desktop software, please print these instructions or refer to *Read This First*. Do the following before installing:

- Turn off your computer and connect the HotSync cradle/cable to it.
- Do *not* simply copy the Palm Desktop software files to your computer's hard disk. You must use the installer to place the files in their proper locations and to decompress the files.

To install Palm Desktop software on a Windows computer:

1. Turn on your computer.
2. Exit any open programs, including those that run automatically at startup such as Microsoft Office, and disable any virus-scanning software.
3. Insert the Palm Desktop software CD-ROM into the computer's CD-ROM drive.
4. Follow the onscreen instructions to complete the installation. During installation you may be asked to connect your handheld to the HotSync cradle/cable.

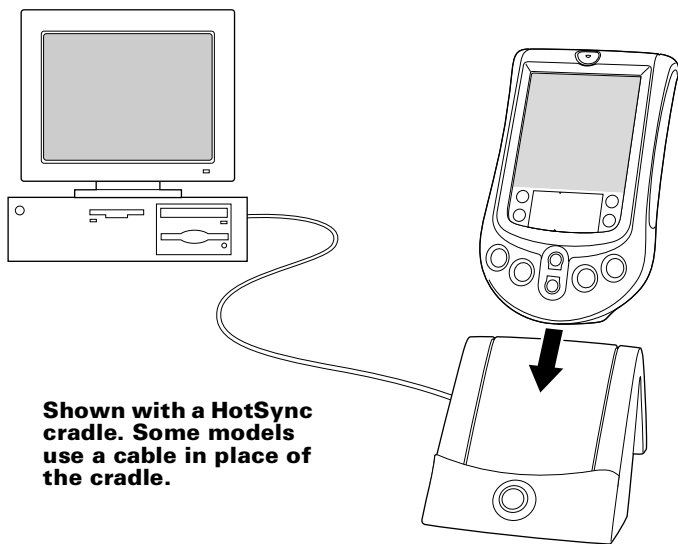

Shown with a HotSync cradle. Some models use a cable in place of the cradle.

To install Palm Desktop software on a Macintosh computer:

1. Turn on your Macintosh.
2. Insert the Palm Desktop software CD-ROM into your Macintosh's CD-ROM drive.
3. Double-click the Palm Desktop CD icon.
4. Double-click the Installer icon to begin the installation procedure.
5. Follow the onscreen instructions to complete the installation.

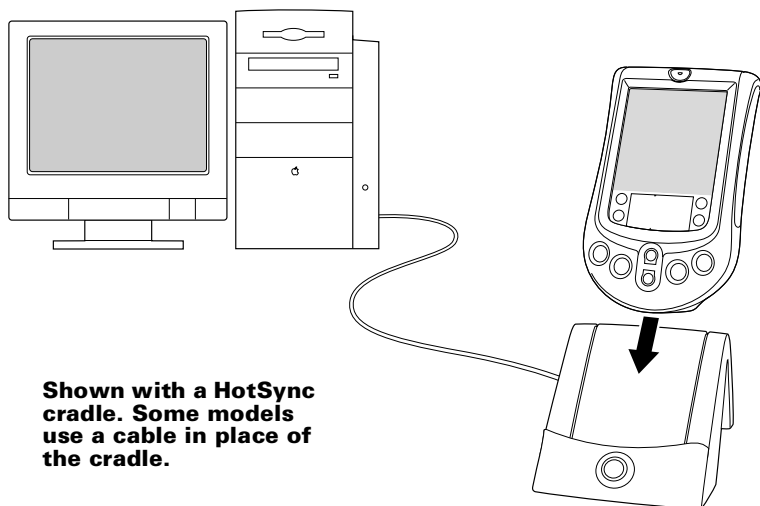

Shown with a HotSync cradle. Some models use a cable in place of the cradle.

Using your handheld with another PIM

If you prefer to use another personal information manager (PIM), such as Microsoft Outlook, you still need to install Palm Desktop software in order to add HotSync Manager, the connection software, and other features of Palm Desktop software to your computer. The connection software, called a conduit, lets you synchronize the data between your handheld and your PIM. The conduit for Microsoft Outlook is included on the Palm Desktop software CD-ROM (Windows only); however you must install it in addition to the Palm Desktop software. For information on the availability of conduit software for the PIM you use, contact the vendor of your PIM or visit the web site <http://www.palm.com>.

Tapping and typing

Tap with the stylus to get things done

Like using a mouse to click elements on a computer screen, using the stylus to tap elements on your handheld screen is the basic action that gets things done on your handheld.

The first time you start your handheld, setup instructions appear on the screen. These instructions include a calibration screen. Calibration aligns the internal circuitry of your handheld with its touch-sensitive screen so that when you tap an element on the screen, the handheld can detect exactly which task you want to perform.

Important: Always use the point of the stylus for tapping or making strokes on the handheld screen. Never use an actual pen, pencil, or other sharp object to write on the handheld screen.

With your handheld turned on, you can tap the handheld screen to do many operations, such as the following:



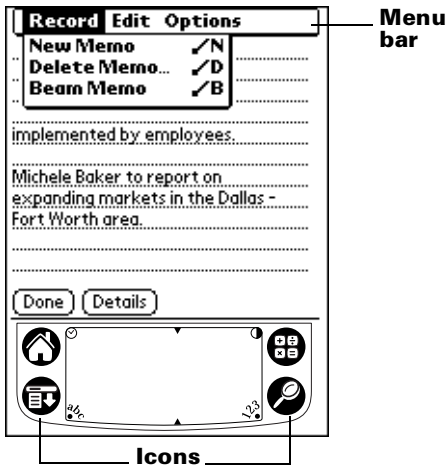

- Open applications
- Choose menu commands
- Initiate a Find operation to search through applications installed on your handheld for specific text (Find operations do not search through applications on expansion cards)
- Select options in dialog boxes
- Open the onscreen keyboards

Just as you can drag the mouse to select text or move objects on your computer, you can also drag the stylus to select text. You can also use the stylus to drag the slider of any scroll bar.

Elements of the handheld interface



Menu bar A set of commands that are specific to the application. Not all applications have a menu bar.

Icons Tap the icons to open applications , menu , Calculator , and to find text anywhere in your data .

Contrast control Tap the Contrast icon  to open the Adjust Contrast dialog box. Tap to the left or right of the slider to adjust the contrast in small increments or drag the slider to change the contrast in large increments. You can also press the up and down scroll buttons to adjust the contrast.

Clock Tap the Clock icon  to display the time and date.

abc With the cursor in an input field, tap the dot to activate the alphabetic keyboard.

123 With the cursor in an input field, tap the dot to activate the numeric keyboard.

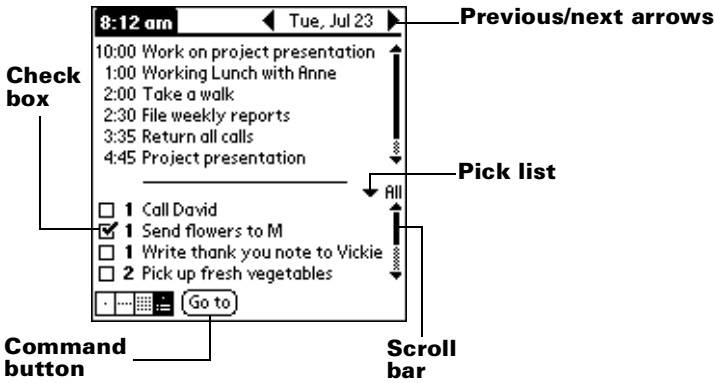

Check box When a check mark appears in a check box, the corresponding option is active. If a check box is empty, tapping it inserts a check mark. If a check box is checked, tapping it removes the check mark.

Command buttons Tap a button to perform a command. Command buttons appear in dialog boxes and at the bottom of application screens.

Next/previous arrows Tap the left and right arrows to display the previous and next record; tap the up and down arrows to display the previous and next page of information.

Pick list Tap the arrow to display a list of choices, and then tap an item in the list to select it.

Scroll bar Drag the slider, or tap the top or bottom arrow, to scroll the display one line at a time. To scroll to the previous page, tap the scroll bar just above the slider. To scroll to the next page, tap the scroll bar just below the slider.

You can also scroll to the previous and next pages by pressing the upper and lower scroll buttons on the front panel of your handheld.

Opening applications

You can use the Applications Launcher to open any application installed on your handheld. You can also open Date Book, Address Book, To Do List, and Note Pad with the application buttons on the front panel of your handheld.

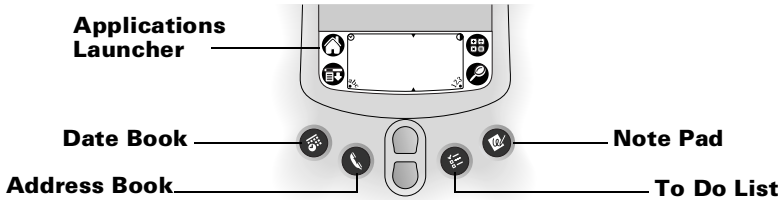

Tip: When you press an application button on the front panel, you have instant access to the selected application. You don't even need to turn on your handheld first.

In addition to providing a way for you to open applications, the Applications Launcher displays the current time, battery level, and application category.

To open an application on your handheld:

1. Tap the Applications icon .



2. Tap the icon of the application that you want to open. If you have many applications installed on your handheld, tap the scroll bar to see all of your applications.

Tip: To find an application quickly, you can write the Graffiti character for the first letter of its name. The Applications Launcher scrolls to the first application with a name that

begins with that letter. You can also assign application icons to different categories. See “Categorizing applications” in Chapter 3.

Note: You can also use applications on expansion cards. See “Opening expansion card applications” in Chapter 4.

Using menus

Menus on your handheld are easy to use. Once you have mastered them in one application, you can use them the same way in all other applications.

The menus of each application are illustrated in the section on that application in Chapter 5. The Edit menu is described in “Editing records” in Chapter 5.

To open the menu bar:

1. Open an application (such as Memo Pad).
2. Do one of the following:
 - Tap the Menu icon .
 - Tap on the inverted title area at the top of the screen.

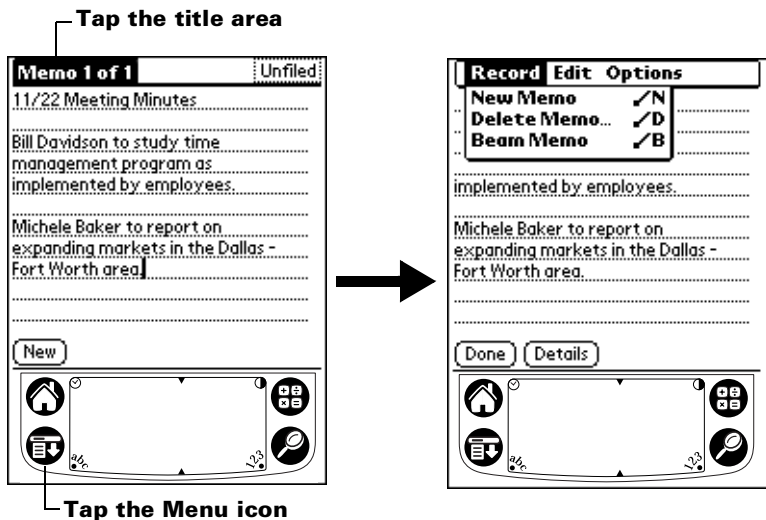

In this example, three menus are available: Record, Edit, and Options. The Record menu is selected and contains the commands New Memo, Delete Memo, and Beam Memo.

Choosing a menu

After you open the menu bar for an application, tap the menu that contains the command you want to use.

The menus and menu commands that are available depend on the application that is currently open. Also, the menus and menu commands vary depending on *which part* of the application you're currently using. For example, in Memo Pad, the menus are different for the Memo list screen and the Memo screen.

Graffiti menu commands

Most menu commands have an equivalent Graffiti Command stroke, which is similar to the keyboard shortcuts used to execute commands on computers. The command letters appear to the right of the command names.

Edit	
Undo	✓U
Cut	✓X
Copy	✓C
Paste	✓P
Select All	✓S

Keyboard	✓K
Graffiti Help	✓G

Menu commands

Command letters

Draw the Command stroke anywhere in the Graffiti area. When you draw the Command stroke, the Command toolbar appears just above the Graffiti writing area to indicate that you are in Command mode.

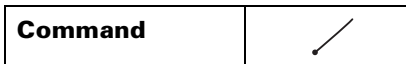

Undo Cut Copy Paste

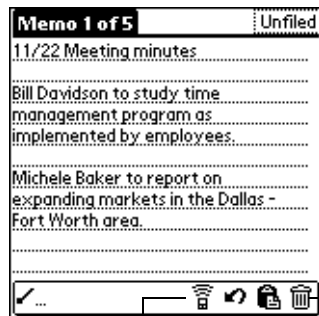

Beam Delete

The command toolbar displays context sensitive menu commands for the current screen. For example, if text is selected the menu icons displayed may be undo, cut, copy, and paste. Tap on an icon to select the command, or immediately write the corresponding command letter for an appropriate command in the Graffiti writing area.

For example, to choose Select All in the Edit menu, draw the Command stroke, followed by the letter "s."

Note: Command mode is only active for a short time, so you must tap an icon or write the command letter immediately to choose the menu command.

Displaying online tips

Many of the dialog boxes that appear on your handheld contain an online Tips icon in the upper-right corner. Online tips anticipate questions you have in a dialog box, provide shortcuts for using the dialog box, or give you other useful information.

To display an online tip:

1. Tap the Tips icon ⓘ.
2. After you review the tip, tap Done.

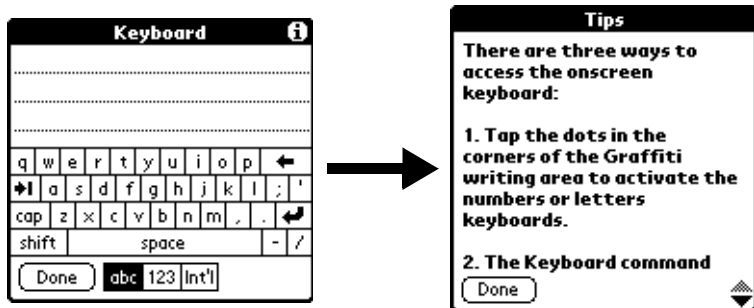

Entering data

There are several ways to enter data into your handheld:

- Using the onscreen keyboard
- Using Graffiti writing
- Using Note Pad
- Entering or importing data in Palm Desktop software and then synchronizing with your handheld

- Using an external keyboard attached to the universal connector
- Beaming data from another Palm OS handheld that is close by and has an infrared port. See “Beaming information” in Chapter 5 for details.

Onscreen keyboard

When you create or edit a record in an application such as Address Book, you can open the onscreen keyboards to enter data.

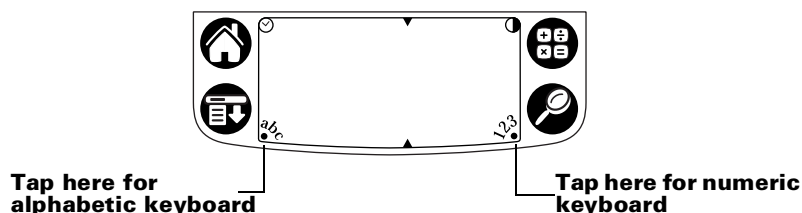

After a keyboard is open, you can tap to open any of the other keyboards, including the international keyboard. See “Using the onscreen keyboard” in Chapter 2 for more information.

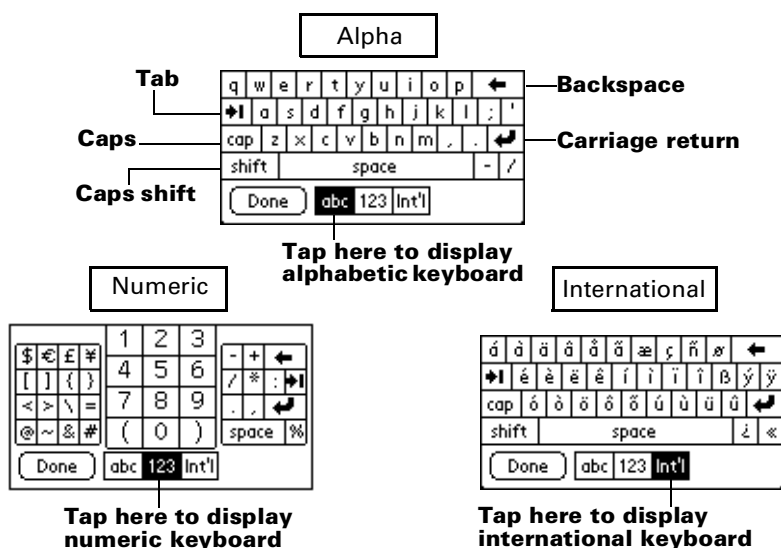

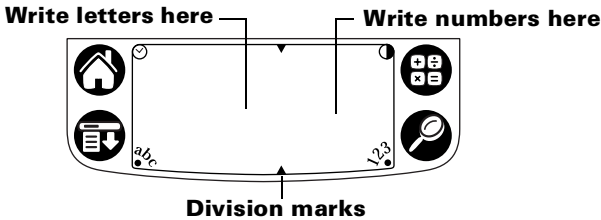

Graffiti writing

Your handheld includes Graffiti writing software as the primary system for entering text and numbers. With Graffiti writing, you write simple strokes with the stylus and they are instantly recognized as letters or numbers.



The Palm Desktop software CD-ROM includes Giraffe, a game you can use to practice Graffiti writing. See "Installing and removing applications" in Chapter 3 for installation instructions. The Memo Pad application is ideal for practicing Graffiti writing. This section explains how to open Memo Pad and use it to practice Graffiti writing.

To open Memo Pad:

1. Tap the Applications icon .
2. Tap the Memo Pad icon .
3. Tap New.

Note: A blinking cursor appears on the first line of the new memo to indicate where the new text will appear.

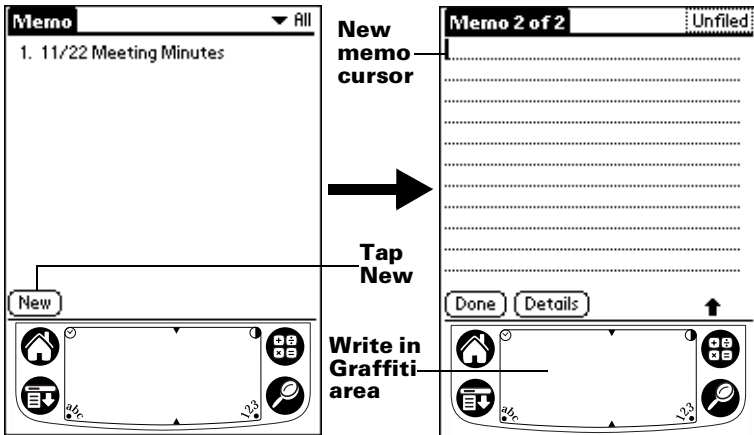

See "Using Graffiti writing to enter data" in Chapter 2 for details.

Note Pad

The Note Pad application provides a place where you can write a quick note in your own handwriting directly on your handheld screen. Think of Note Pad as a virtual “sticky pad” for short notes. Later, you would transfer your “sticky” notes to a more permanent place by entering the information in the appropriate application, or throw them away by deleting them. See “Note Pad” in Chapter 5 for more information and instructions.

Using Palm Desktop software

If you have new records you want to add to your handheld and prefer to use the computer keyboard rather than Graffiti writing or the onscreen keyboard, enter the data in Palm Desktop software or the PIM you have installed to use with your handheld. For details on entering information in Palm Desktop software, refer to the online Help in Palm Desktop software, the *Quick Tour* in Palm Desktop software (for Windows users), and the *Palm Desktop Software for the Macintosh User's Guide* located in the Documentation folder in the Palm Desktop folder.

After the information is in Palm Desktop software, perform a HotSync operation to synchronize your handheld with your computer. See “Exchanging and updating data: HotSync operations” in Chapter 5 for more information.

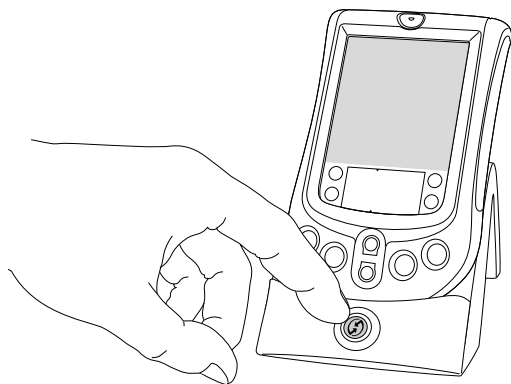

Importing data

If you already have data in a database on your computer, you can import it into Palm Desktop software. You can import data stored in computer applications such as spreadsheets and databases, or from another Palm OS handheld. When you import data, you transfer the

records to your handheld without having to enter them manually. See “Importing data” in Chapter 2 for more information.



Using an external keyboard

You can connect an optional keyboard accessory to the universal connector on your handheld so you can type data directly into your handheld. External keyboards are very helpful when you need to enter large amounts of data quickly and accurately while you are away from your computer. For additional information about this optional accessory, visit the web site <http://www.palm.com>.

Customizing your handheld

You can customize your handheld by using the Preferences application. You can enter personal information such as your name and address; change the time, date, and time zone; view different date and time formats when you travel; turn off sounds; and configure your handheld to work with a modem. See Chapter 7 for details.

To open the Preferences screens:

1. Tap the Applications icon .
2. Tap the Preferences icon .
3. Tap the category pick list in the upper-right corner of the screen.
4. Tap the Preferences category you want to view.

The following procedures for setting the date give you an example of how to customize your handheld.

You make changes to the date and time in Date and Time preferences.

To set the date:

1. Tap the Set Date box.
2. Tap the arrows to select the current year.

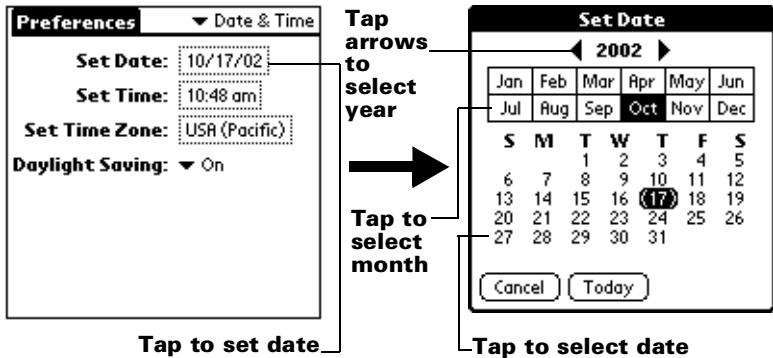

3. Tap a month.
4. Tap the current date.

To set the time:

1. Tap the Set Time box.

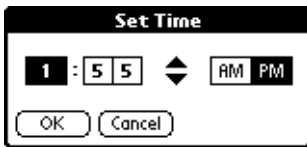

2. Tap the up or down arrows to change the hour.
3. Tap each number of the minute, and then tap the arrows to change them.
4. Tap OK.

To set the time zone:

1. Tap the Set Time Zone box.



2. Tap a time zone.

Tip: When you travel, changing the time zone setting to a new time zone automatically resets the date and time on your handheld, but it does not change the time of appointments set in Date Book.

3. Tap OK.

To set the daylight saving switch:

- Tap the Daylight Saving pick list, and then tap Off or On.

Chapter 2

Entering Data in Your Handheld

This chapter explains how to enter data into your handheld by writing with the stylus in the Graffiti® writing area, by using the onscreen keyboard, by using the computer keyboard, or by importing data from another application.

Using Graffiti writing to enter data

Chapter 1 introduced Graffiti writing and briefly described how to use it to enter text in your applications. In this section, you learn the procedures for creating letters, numbers, punctuation, and symbols, as well as some Graffiti tips and tricks.

Writing Graffiti characters

Most people find they can enter text quickly and accurately with only minutes of practice. Graffiti writing includes any character you can type on a standard keyboard. The Graffiti strokes closely resemble the uppercase letters of the regular alphabet, which makes Graffiti writing easy to learn.

There are four basic concepts for success with Graffiti writing:

- If you draw the character shape exactly as shown in the tables later in this chapter (like the shapes shown in the following diagram), you achieve 100% accuracy.



- The heavy dot on each shape shows where to begin the stroke. Certain characters have similar shapes, but different beginning and end points. Always begin the stroke at the heavy dot (you should not create the heavy dot; it is only there to show you where to begin the stroke).

- Most characters require only a single stroke. When you lift the stylus from the Graffiti writing area, your handheld recognizes and displays the text character immediately. To accomplish single strokes, some Graffiti strokes are portions of the regular alphabet equivalents.
- The Graffiti writing area is divided into two parts: one for writing the letters of the alphabet and one for writing numbers. The small marks at the top and bottom of the Graffiti writing area indicate the two areas.

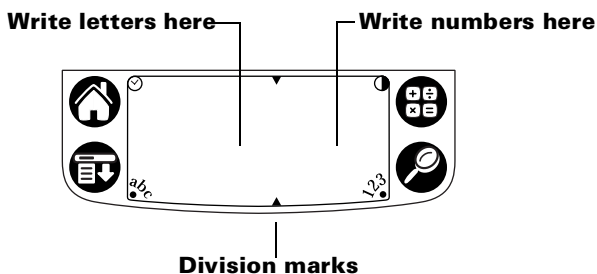

To write Graffiti letters:

1. Tap the screen where you want your text to go.

Note: You need to tap above the Graffiti writing area, and must see a blinking cursor before you write the text.

2. Use the tables on the following pages to find the stroke shape for the letter you want to create. For example, the stroke shown below creates the letter "n."

Note: There are two different stroke shapes available for some letters. For these letters, choose the one that's easiest for you.

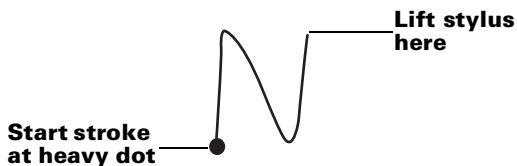

As you'll see later, you use the same shape to create both the uppercase and lowercase version of a letter.

3. Position the stylus in the left-hand side of the Graffiti writing area.
4. Start your stroke at the heavy dot and draw the stroke shape as it appears in the tables.
5. Lift the stylus from the screen at the end of the stroke shape.

That's all there is to it! When you lift the stylus from the screen, your handheld recognizes your stroke immediately and prints the letter at the insertion point on the screen.

As soon as you lift the stylus from the screen, you can begin the stroke for the next character you want to write.













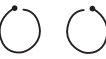















Important: You must begin the character strokes in the Graffiti writing area. If you do not make Graffiti strokes in the Graffiti writing area, your handheld does not recognize them as text characters.

Graffiti tips

When using Graffiti writing, keep these tips in mind:

- Accuracy improves when you write large characters. You should draw strokes that nearly fill the Graffiti writing area.
- To delete characters, simply set the insertion point to the right of the character you want to delete and make the backspace stroke (a line from right to left) in the Graffiti writing area.
- Write at natural speed. Writing too slowly can generate recognition errors.
- Do not write on a slant. Vertical strokes should be parallel to the sides of the Graffiti writing area.
- Press firmly.

The Graffiti alphabet

Letter	Strokes	Letter	Strokes
A		N	
B		O	
C		P	
D		Q	
E		R	
F		S	
G		T	
H		U	
I		V	
J		W	
K		X	
L		Y	
M		Z	
Space		Back Space	
Carriage Return		Period	tap twice

Writing capital letters

You make capital letters with the same stroke shapes as the basic alphabet characters. To make capital letters, you must first “shift” to caps — just as you press the Shift key on a keyboard — and then write the character strokes.

Note: Graffiti writing includes a feature that automatically capitalizes the first letter when you create a new sentence or a new record (by tapping New or a blank line).

To draw the first letter of a word as a capital letter:

- Use the Caps Shift stroke:

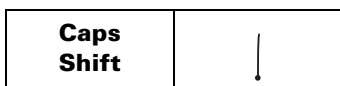

Tip: When Caps Shift is active, an “up arrow” symbol appears in the lower-right corner of the handheld screen. If you accidentally activate Caps Shift, backspace will cancel it.

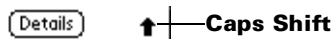

To enter only capital letters (Caps Lock):

- Use the Caps Lock stroke:

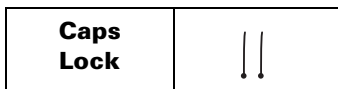

Tip: When Caps Lock is active, an underlined “up arrow” symbol appears in the lower-right corner of the handheld screen. To return to lowercase, make the Caps Shift stroke.

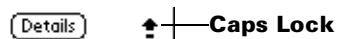

Writing numbers

Writing numbers with Graffiti writing is similar to writing letters of the alphabet, except that you make the character strokes on the right-hand side (numbers side) of the Graffiti writing area.

Graffiti numbers

Number	Strokes	Number	Strokes
0		5	
1		6	
2		7	
3		8	
4		9	

Writing punctuation marks

Graffiti writing can create any punctuation symbol that you can enter from a standard keyboard. All punctuation marks begin with a single tap on the Graffiti writing area. When you make this tap, you activate Punctuation Shift and a dot appears to show it is active. The next stroke you make with the stylus creates a punctuation mark.

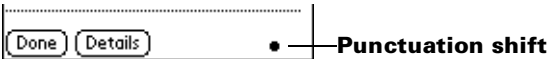

Note: When Punctuation Shift is active, you can make a symbol stroke anywhere in the Graffiti writing area (the letters *or* numbers side).

Symbol	Stroke	Symbol	Stroke
Period .		Dash —	
Comma ,		Left Paren (
Apostrophe '		Right Paren)	
Question ?		Slash /	

Exclamation !	!	Dollar \$	\$
-------------------------	---	---------------------	----

Additional Graffiti punctuation

@	#	%	^	&	*	<	>	_	+	=	
o	v	w	^	g	o	<	>	-	o	z	!
\	{	}	[]	~	`	;	:	"	tab	
\	e	3	e	3	N	\	/	v	N	Γ	

Writing symbols and extended characters

All symbols and extended characters begin with the stroke in the Graffiti writing area of your handheld:

Symbol Shift	
---------------------	--

When the Symbol Shift is active, a slanted shift symbol appears in the lower-right corner of the screen. The next stroke that you make creates the symbol or extended character.

Details		Symbol Shift
----------------	--	---------------------

•	™	®	©	´	˘	“	”	§	°
•	M	R	C	Γ	7	N	v	S	o
+	-	X	÷	=	¢	€	¥	£	i
o	-	/	w	Z	C	E	Y	L	L
i	ß	µ	f	ø					
!	ß	M	S	o					

Writing accented characters

To create accented characters, draw the stroke normally used to create the letter, followed by an accent stroke. Graffiti writing then adds the accent to the letter.

For example, the following diagram shows the strokes required to draw an accented “e.”

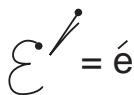

Accent strokes

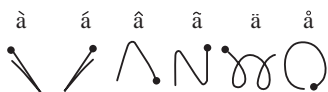

Using these accent strokes, you can write the following accented letters:

à á â ã ä å è é ê ë ì í î ï ò ó ô õ ö ù ú û ü ÿ ý ñ

Additional non-English characters

You can write the following characters without any special punctuation or shifting:

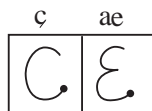



Note: You must write these non-English characters in the left side of the Graffiti writing area.

Navigation strokes

In addition to character symbols, Graffiti writing includes special strokes that you can use to navigate within text or fields in your applications.

Command	Stroke
Move cursor right	
Move cursor left	

Previous field (Address Book only)	
Next Field (Address Book only)	
Open Address Record (Address Book only)	

Graffiti ShortCuts

Graffiti ShortCuts make entering commonly used words or phrases quick and easy. ShortCuts are similar to the Glossary or Autotext features of some word processors.

Graffiti writing comes with several predefined ShortCuts, and you can also create your own. Each ShortCut can represent up to 45 characters. For example, you might create a ShortCut for your name, or for the header of a memo. See “ShortCuts preferences” in Chapter 7 to learn about creating your own ShortCuts.

To use a ShortCut, draw the ShortCut stroke followed by the ShortCut characters. When you draw the ShortCut stroke, the ShortCut symbol appears at the insertion point to show that you are in ShortCut mode.

ShortCut	
-----------------	---

Your handheld includes the following predefined Graffiti ShortCuts:

Entry	ShortCut
Date stamp	ds
Time stamp	ts
Date/time stamp	dts
Meeting	me
Breakfast	br
Lunch	lu
Dinner	di

Using the onscreen keyboard

You can open the onscreen keyboard anytime you need to enter text or numbers on your handheld.

To use the onscreen keyboard:

1. Open any application (such as Memo Pad).
2. Tap any record, or tap New.
3. Tap “abc” to open the alphabetic keyboard, or tap “123” to open the numeric keyboard.

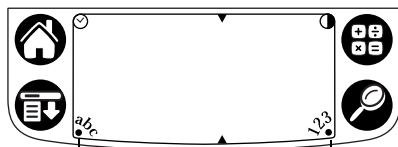

Tap here for
alphabetic keyboard

Tap here for numeric
keyboard

4. Tap the characters to enter text and numbers.

Note: The onscreen keyboard also includes a dialog box for international characters. You can switch among the three dialogs at any time to enter the exact text you need.

5. After you finish, tap Done to close the onscreen keyboard and place the text in the record.

Using Note Pad

In addition to using Graffiti characters and the onscreen keyboard, you can enter data on your handheld using the Note Pad application. When you use Note Pad, you write quick notes directly on the handheld screen in your own handwriting. Later, you can enter this information into another application, or delete it. See “Note Pad” in Chapter 5 for more information and instructions.

To use Note Pad:

1. Press the Note Pad application button  on the front panel of your handheld.
2. Write the information directly on the handheld screen.
3. Tap Done.

Using your computer keyboard

If you have a lot of data to enter, or prefer to use the computer keyboard, you can use Palm™ Desktop software or any supported PIM to enter information. You can then perform a HotSync® operation to synchronize the information on your computer with the information on your handheld. Most of the applications that came with your handheld are also available in Palm Desktop software and in most PIMs, so you don't need to learn different applications. For more information on entering data on your computer, refer to the online Help in Palm Desktop software, the *Quick Tour* in Palm Desktop software (for Windows users), and the *Palm Desktop Software for the Macintosh User's Guide* on the Palm Desktop software CD-ROM.

Importing data

If you have data stored in computer applications such as spreadsheets and databases, or if you want to import data from another handheld, you can transfer the data to your handheld without having to key it in manually. Save the data in one of the file formats listed below, import it into Palm Desktop software, and then perform a HotSync operation to transfer the data to your handheld.

Importing data from a Windows computer

Palm Desktop software can import data in the following file formats:

- Comma delimited (.csv, .txt): Address Book and Memo Pad only
- Tab delimited (.tab, .tsv, .txt): Address Book and Memo Pad only
- CSV (Lotus Organizer 2.x/97 Mapping): Address Book only
- vCal (.vcs): Date Book only
- vCard (.vcf): Address Book only
- Date Book archive (.dba)
- Address Book archive (.aba)
- To Do List archive (.tda)
- Memo Pad archive (.mpa)

Archive formats can only be used with Palm Desktop software. Use the archive file formats to share information with other people who use a Palm OS® handheld or to create a copy of your important Palm Desktop information.

To import data from a Windows computer:

1. Open Palm Desktop software.
2. Click the application into which you want to import data.
3. If you are importing records that contain a field with category names, do the following:

Select All in the Category box.

Be sure that the same categories that appear in the imported file also exist in the application. If the categories do not exist, create them now; otherwise, the records are imported into the Unfiled category.

4. From the File menu, choose Import.
5. Select the file you want to import.
6. Click Open.

Note: If you are importing a vCal or vCard file, skip to step 10. You do not have to specify which fields correspond to the imported data.

7. To import data into the correct Palm Desktop fields, drag fields in the left-hand column so that they are opposite the corresponding imported field on the right.
8. If you do not want to import a field, deselect the check box for that field.
9. Click OK.
The imported data is highlighted in the application.
10. To add the imported data to your handheld, perform a HotSync operation.

See Palm Desktop online Help for more information on importing and exporting data.

Importing data from a Macintosh

Palm Desktop software can import data from any of the following applications when you export the data in the appropriate file format:

- Address Book Plus (text file)
- Claris Organizer (Palm Desktop software can open these files directly)
- ClarisWorks (save under new name as ASCII text file)
- DateBook Pro (text file)

- DayMaker (text file)
- Dynodex (text file)
- FileMaker Pro (tab separated text file)
- Meeting Maker (text file)
- Newton running OS 1.0 with Newton Connection Kit: Names; Date Book Calendar; and Notepad (text file)
- Now Contact (text file)
- Now Up-to-Date (text file)
- QuickDex (text file)
- TouchBase Pro (text file)

To import data from a Macintosh:

1. Open Palm Desktop software.
2. From the File menu, choose Import.
3. Select the file you want to import.
4. Click Open.
5. If you want to change the order of the fields you're importing, point to a field, wait for the cursor to change to a double arrow, and then drag the field to a new location.
6. If you do not want to import a field, click the arrow between the field names.
7. From the Fields pop-up menu, choose the appropriate field.
8. From the Delimiters pop-up menu, choose the appropriate delimiter.
9. Click OK.
10. To add the imported data to your handheld, perform a HotSync operation.

See Palm Desktop online Help for more information on importing and exporting data.

Chapter 3

Managing Your Applications

This chapter explains how to switch between applications on your handheld, how to change application settings so they are personalized to your work methods, and how to categorize applications so you view them in related groups. For information about working with applications on an expansion card, see Chapter 4.

Using the Applications Launcher

To open the Applications Launcher, tap the Applications icon .

Selecting applications

Your handheld is equipped with a variety of applications. All the applications installed on your handheld appear in the Applications Launcher. See “Opening applications” in Chapter 1 for details. Applications installed on an expansion card appear immediately in the Applications Launcher when you insert an expansion card, or when you select the card from the pick list in the upper-right screen. See “Opening expansion card applications” in Chapter 4 for details.



Switching between applications

When working in any application, tap the Applications icon  or press an application button on the front panel of your handheld to switch to another application. Your handheld automatically saves your work in the current application and displays it when you return to that application. You can also switch between applications on your handheld and applications on expansion cards. See “Switching between your handheld and an expansion card” in Chapter 4 for details.

Categorizing applications

The category feature enables you to manage the number of application icons that appear onscreen in the Applications Launcher. You can assign an application to a category and then display a single category or all your applications.

To categorize an application:

1. Tap the Applications icon .
2. Tap the Menu icon .
3. Tap App, and then tap Category.
4. Tap the pick list next to each application to select a category.

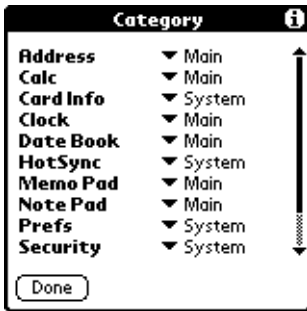

Tip: To create a new category, tap Edit Categories from the pick list. Tap New, enter the category name, and then tap OK to add the category. Tap OK.

5. Tap Done.



To display applications by category:

1. Tap the Applications icon .
2. Do one of the following:
 - Tap the Applications icon repeatedly to cycle through all your categories.
 - Tap the pick list in the upper-right corner of the screen and select the category you want to display.

Changing the Applications Launcher display

By default, the Applications Launcher displays each application as an icon. As an alternative, you can choose to show a list of applications. You can also choose to view the same category of applications each time you open the Applications Launcher.



To change the Applications Launcher display:

1. Tap the Applications icon .
2. Tap the Menu icon .

3. Tap Options, and then tap Preferences.
4. Tap the View By pick list and select List.
5. Tap OK.



To open the Applications Launcher to the last opened category:

1. Tap the Applications icon .
2. Tap the Menu icon .
3. Tap Options, and then tap Preferences.
4. Tap the Remember Last Category check box to select it.
5. Tap OK.

Choosing preferences

You can set options that affect an entire application in the application's Preferences dialog box.

To change preferences for an application:

1. Open an application.
2. Tap the Menu icon .
3. Tap Options, and then tap Preferences.

Note: Not all applications have a Preferences command.
4. Make changes to the settings.
5. Tap OK.

Installing and removing applications

This section explains how to install and remove applications on your handheld or on an expansion card, and how to remove Palm™ Desktop software from your computer.

Installing add-on applications

Your handheld comes with the Date Book, Address Book, To Do List, Note Pad, Memo Pad, and Calculator applications installed and ready to use.

You can also install additional applications on your handheld or on a card that is seated in the expansion card slot, such as games and other software. The Install Tool makes it easy to install software during a HotSync® operation. There are a variety of third-party applications available for your handheld. To learn more about these applications, visit the web site <http://www.palm.com>.

Note: Any game or application that you install on your handheld resides in RAM memory; you can delete them at any time.

To install add-on software on your handheld using a Windows computer:

1. On your computer, copy or download the application you want to install into the add-on folder in your Palm Desktop directory on your computer.

Note: If the software you download is compressed, you need to decompress it into this folder. If you prefer to place the application into another folder, you need to navigate to that folder before you complete step 5.

2. Double-click the Palm Desktop icon on your desktop.
3. Click Install.

Tip: You can also access the Install Tool dialog by selecting Install Tool from the Palm Desktop program group or by double-clicking any file with a PRC, PDB, PQA, PNC, or SCP file extension.

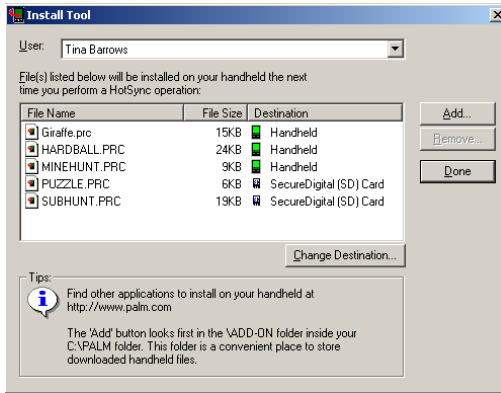

4. In the User drop-down list, select the name that corresponds to your handheld.
5. Click Add.

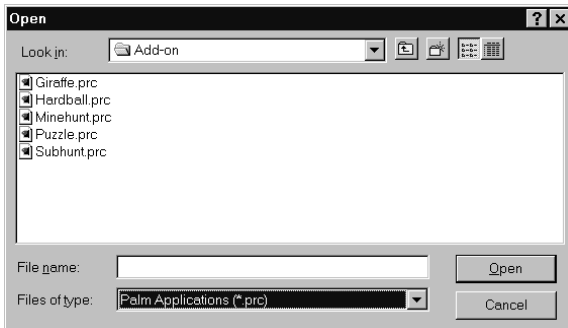

6. Select the application(s) that you want to install on your handheld or on a resident expansion card.
7. Click Open.

Note: Review the list of applications you selected in the Install Tool dialog box. If you do not want to install an application, select it, and then click Remove. (This does not remove the application from your computer; it simply removes it from the list of applications to install.)

8. If you need to change the destination of the application you are installing, click Change Destination on the Install Tool window, and then use the arrows to move applications between your handheld and an expansion card.

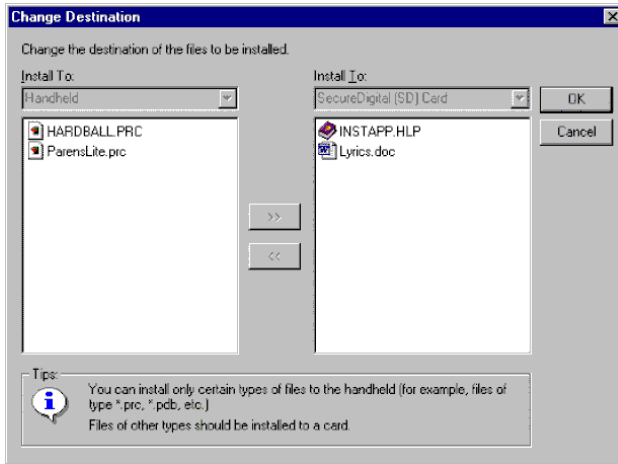

9. Click OK to close the Change Destination window.
10. Click Done to close the Install Tool window.
11. Perform a HotSync operation to install the selected application(s). See “Exchanging and updating data: HotSync operations” in Chapter 5 for details.

Note: Files that remain in the list after you perform a HotSync operation did not install. This can happen if the file type was not recognized during the HotSync operation. Expansion cards may hold applications that use files other than the Palm™ application files. In order for your handheld to recognize such a file, you must launch the application that uses these files at least once.

To install add-on software on your handheld using a Macintosh:

1. On your Macintosh, copy or download the application you want to install into the add-on folder in your Palm folder.

Note: If the software you download is compressed, you need to decompress it into this folder.
2. Double-click the Hotsync Manager icon in the Palm folder.

3. From the HotSync menu, choose Install Handheld Files.

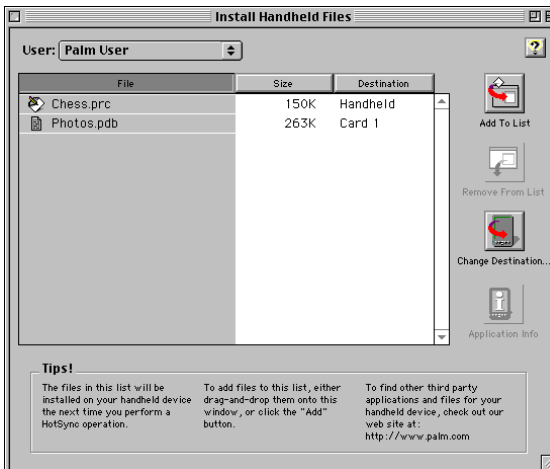

4. From the User pop-up menu, select the name that corresponds to your handheld.
5. Click Add to List.
6. Select the Add-on folder from the pop-up menu.

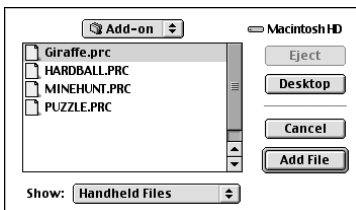

7. Select the application you want to install.
8. Click Add File to add the selected application to the Install Handheld Files list.

- If you need to change the destination of the application you are installing, click Change Destination on the Install Handheld Files window, and then use the arrows to move applications between your handheld and an expansion card.

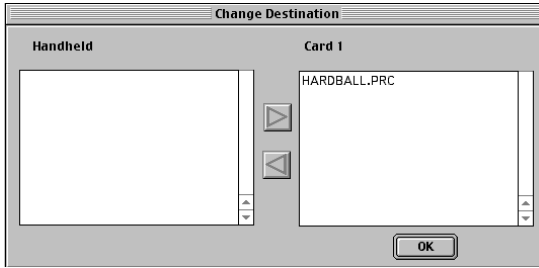



- Click OK to close the Change Destination window.
- Close the Install Handheld Files window.
- Perform a HotSync operation to install the selected application(s) on your handheld. See “Exchanging and updating data: HotSync operations” in Chapter 5 for details.

Note: Files that remain in the list after you perform a HotSync operation did not install. This can happen if the file type was not recognized during the HotSync operation. Expansion cards may hold applications that use files other than the Palm application files. In order for your handheld to recognize such a file, you must launch the application that uses these files at least once.

Removing applications

In the event that you run out of memory or decide that you no longer need an application you installed, you can remove applications from your handheld or from an expansion card. From your handheld, you can remove only add-on applications, patches, and extensions that you install; you cannot remove the applications that reside in the ROM portion of your handheld.

To remove an add-on application:

- Tap the Applications icon .
- Tap the Menu icon .
- Tap App, and then tap Delete.

4. Tap the Delete From pick list and select either Handheld or Card. To delete applications from a card, the card must be seated in the expansion card slot.
5. Tap the application that you want to remove.



6. Tap Delete.
7. Tap Yes.
8. Tap Done.

Removing Palm Desktop software

If you no longer want to use Palm Desktop software, you can remove it from your computer.

To remove Palm Desktop software from a Windows computer:

1. From the Windows Start menu, choose Settings, and then choose Control Panel.
2. Double-click the Add/Remove Programs icon.
3. Click the Change or Remove Programs button.
4. Select Palm Desktop.
5. Click Change/Remove.
6. Click Yes in the Confirm File Deletion box.
7. Click OK.
8. Click Close.

Note: You need to install the HotSync Manager from the installation CD if you want to synchronize data with another PIM.

To remove Palm Desktop software from a Macintosh:

1. Locate the Palm Desktop Installer icon and double-click this icon.
2. From the Easy Install screen, choose Uninstall from the pop-up menu.
3. Select the software you want to remove.
4. Click Uninstall.
5. Select the folder that contains your Palm Desktop software files.
6. Click Remove.

Note: This process removes only the application files. The data in your Users folder remains untouched.

7. Restart your Macintosh.

Security

Your handheld comes with a Security application so that unauthorized users cannot view the entries you wish to protect.

In Security, you can do the following:

- Lock and turn off your handheld so that it does not operate until you enter the correct password.
- Mask all records that you mark as private so the information appears greyed out.
- Hide all records that you mark as private so they do not appear on any screen.

You can mask and hide private records with or without a password. Without a password, private records are hidden or masked until you set the Security application to show them. With a password, you must enter the password to view the private entries. See “Making records private” in Chapter 5 for information.

Assigning a password

You can assign a password to protect your private records and to lock your handheld.

To assign a password:

1. Tap the Applications icon .
2. Tap the Security icon.

3. Tap the Password box.
4. Enter a password.
5. Enter a hint to help your remember your password if you forget it. This is optional.

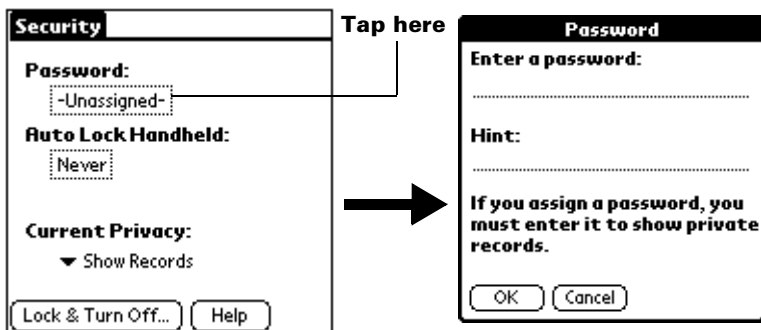

6. Tap OK.
7. Enter the *same* password a second time, and tap OK.

Changing or deleting a password

Once you define a password for your handheld, you can change or delete it at any time. You must enter the current password before you can change or delete it.

To change or delete your password:

1. Tap the Password box.
2. Enter the current password.

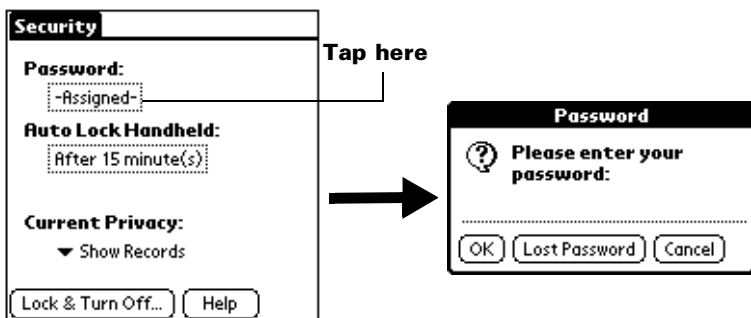

3. Tap OK.

4. Do one of the following:

To change the password and hint, enter the new password and hint, and tap OK.

To remove the password, tap Unassign.



Locking your handheld

You can lock your handheld so that it cannot be operated until your password is entered. In the event that your handheld is lost or stolen, this helps protect your data from unauthorized use. You can set your handheld to lock automatically, or you can lock it manually.

Locking your handheld automatically

You can set your handheld to lock automatically when any one of the following occur:

- When you turn off the power
- At a time you specify
- After a period of inactivity you specify

To set your handheld to lock when you turn it off:

1. Tap the Applications icon .
2. Tap the Security icon.

3. Tap the Auto Lock Handheld box, and then enter your password.

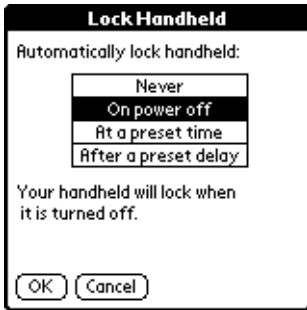

4. Tap On power off.
5. Tap OK.

To set your handheld to lock at a preset time:

1. Tap the Applications icon .
2. Tap the Security icon.
3. Tap the Auto Lock Handheld box, and then enter your password.
4. Tap At a preset time, and then use the arrows to set the time.

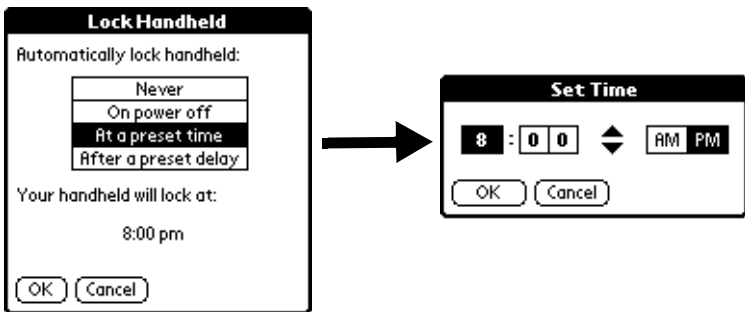

5. Tap OK.

To set your handheld to lock after a period of inactivity:

1. Tap the Applications icon .
2. Tap the Security icon.
3. Tap the Auto Lock Handheld box, and then enter your password.
4. Tap After a preset delay.

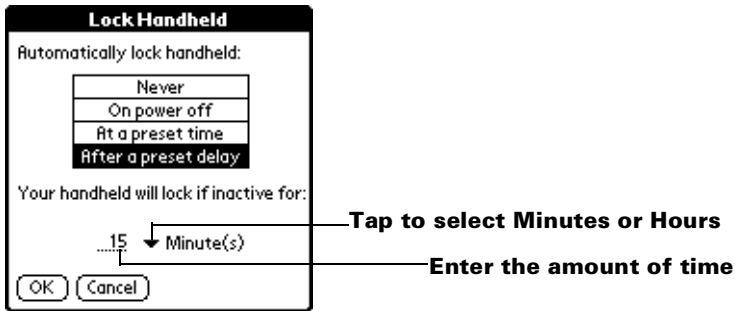

5. Enter the inactive period, then select Minute(s) or Hour(s) from the pick list.
6. Tap OK.

Important: If you lock your handheld, you must enter the exact password to re-activate your handheld. If you forget the password, your handheld will present the hint you have entered to help you remember the password. If you still cannot remember the password, you must perform a hard reset to resume using your handheld. Performing a hard reset deletes all the records in your handheld; however, you can restore all synchronized data at the next HotSync operation. See “Resetting your handheld” in Appendix A for more information.

Locking your handheld manually

You can turn off and lock your handheld manually.

To lock and turn off your handheld:

1. Tap the Applications icon .
2. Tap the Security icon.
3. Tap Lock & Turn Off.

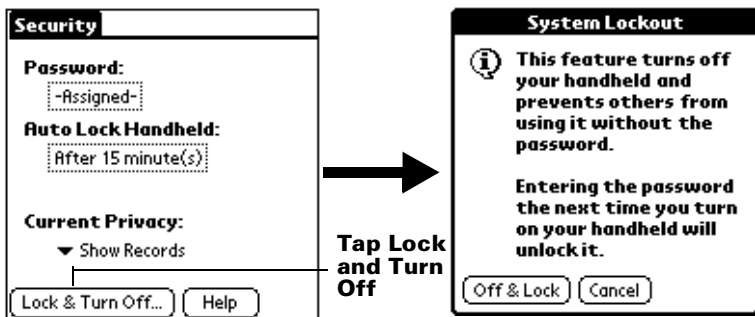

4. Tap Off & Lock.
5. To start your handheld, turn it on and then enter the password.

Recovering from a forgotten password

If you forget your password, your handheld will display the password hint, if you entered one, to help you remember the password. If you are still unable to remember the password, you can delete it from your handheld. Deleting a forgotten password also deletes all entries and files marked as Private.

Important: If you synchronize with your computer before deleting a forgotten password, your handheld restores your private entries the next time you perform a HotSync operation, but it does not restore the password.

To delete a forgotten password:

1. Tap Lost Password.
2. Tap Yes.

Chapter 4

Using Expansion Features

Your handheld provides an expansion card slot that enables you to add additional software applications and memory. You can also use a special kind of expansion card that allows you to back up your data when it is inconvenient to perform a HotSync® operation.

Note: Battery life may vary depending on the expansion cards used.

Your handheld is also equipped with a universal connector so that you can easily attach and use peripheral hardware devices, such as a modem, portable keyboard, or a Global Positioning System (GPS) receiver. For information about the installation and operation of hardware devices, please refer to the documentation that accompanies each device.

Inserting an expansion card

1. Hold your handheld securely.
2. Insert the card into the expansion card slot, following the direction indicated by the expansion card icon on the back panel of your handheld.

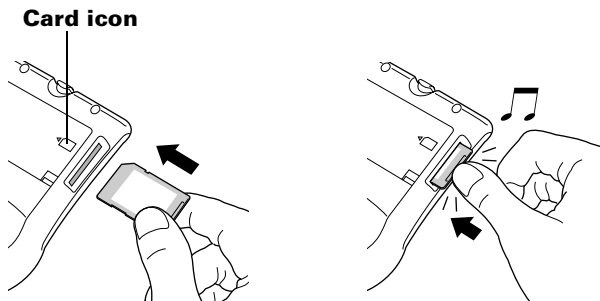

3. Use your thumb to push the card into the expansion slot. When you feel the card lock and hear the audible system sound, the card is properly seated within the slot.

Removing an expansion card

1. Hold your handheld securely.
2. Use your thumb to push against the top of the card, as if you were pushing it further into the slot. The expansion card slot releases the card, and your handheld makes an audible system sound.

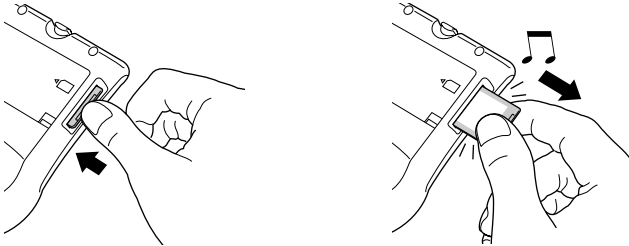

3. Once the slot has released the card, gently remove the card from the expansion card slot.

Note: Your handheld comes with a dummy card seated within the expansion card slot. To prevent debris from entering and damaging the slot, we suggest that you leave the dummy card seated when you are not using an expansion card.

Opening expansion card applications

When an expansion card is properly seated in the expansion card slot, the Applications Launcher switches to the card and displays its contents. The pick list in the upper-right corner of the screen displays the name of the card.

To open an application on an expansion card:

- Tap the icon of the application that you want to open.

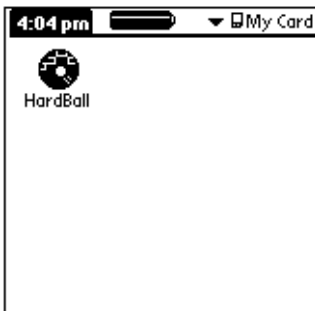

Switching between your handheld and an expansion card

When you use an expansion card, your handheld creates and displays a new category that matches the name of the expansion card. You can easily switch between applications installed on your handheld and on the expansion card.

To switch to an expansion card:

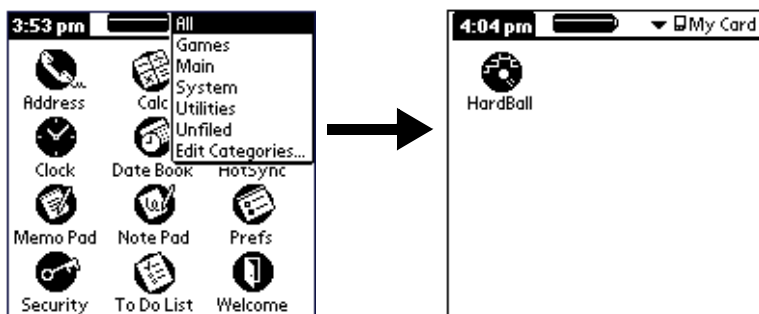

1. Tap the pick list in the upper-right corner.
2. Tap the category item that matches the name of the expansion card.



Copying applications to an expansion card

You can copy applications from your handheld to an expansion card, or from an expansion card to your handheld.

To copy an application to an expansion card:

1. Tap the Applications icon .
2. Tap the Menu icon .

3. Tap App, and then tap Copy.

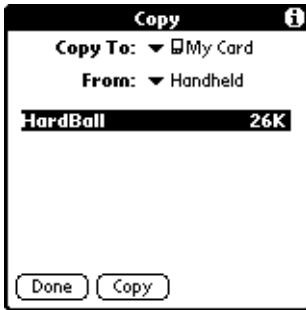



4. Select the card name from the Copy To pick list.
5. Select Handheld from the From pick list.
6. Tap an application to copy.
7. Tap Copy.
8. Tap Done.

Note: You can install applications to a card that is seated in the expansion card slot during a HotSync operation; see “Installing add-on applications” in Chapter 3 for details. Also, you can beam applications from expansion cards; see See “Beaming information” in Chapter 5 for details.

Note: If you copy applications between your handheld and multiple expansion cards, and then attach a card with a copied application to a Card Reader/Writer, you may notice that the copied application’s filename has been changed to the name of a database file it contains. You will only see this if you use your cards with a Card Reader/Writer.

Deleting applications from an expansion card

To delete applications from an expansion card:

1. Tap the Applications icon .
2. Tap the Menu icon .
3. Tap App, and then tap Delete.

4. Tap the card name from the Delete From pick list.
5. Tap an application to delete from the expansion card.





6. Tap Delete.
7. Tap Done.

Card Info





Card Info lets you review general information about a resident card and its contents, rename a card, and format a card.

Reviewing card information

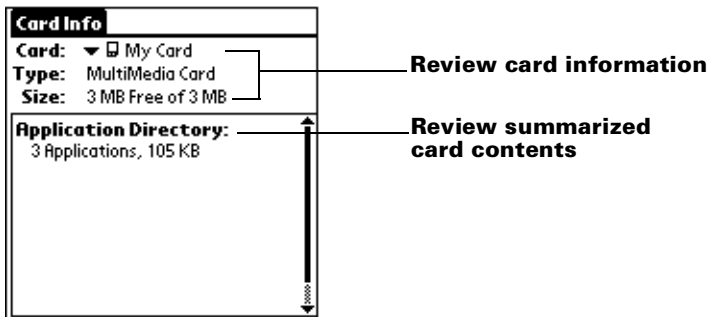
1. Tap the Applications icon .
2. Tap the Card Info icon .
3. Review Card name, Type, and Size.
4. Review card contents summarized by directory.



Renaming a card

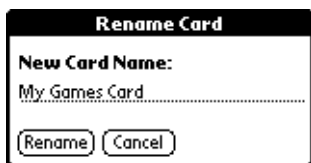

1. Tap the Applications icon .
2. Tap the Card Info icon .
3. Tap the Menu icon.
4. Tap Card, and then tap Rename Card.



5. Enter the new name for the card.
6. Tap Rename.

Formatting a card

Formatting a card destroys all its data and prepares it to accept new applications and data.

1. Tap the Applications icon .
2. Tap the Card Info icon .
3. Tap the Menu icon.
4. Tap Card, and then tap Format Card.
5. Tap OK.

Card Info menus

Card Info menus are shown here for your reference, and Card Info features that are not explained elsewhere in this book are described here.

See “Using menus” in Chapter 1 for information about choosing menu commands.

Card menus

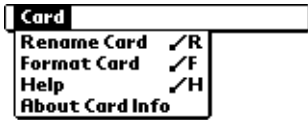

Help Provides help text.

About Card Info Shows version information for Card Info.

Chapter 5

Using Your Basic Applications

Your handheld includes these basic applications:

- Date Book
- Address Book
- To Do List
- Note Pad
- Memo Pad
- Clock
- Calculator

This chapter is divided into three sections:

- “Overview of basic applications” briefly describes each application and explains how to open it.
- “Common tasks” gives instructions on how to do tasks that you can do in most or all of the basic applications. It’s easy to transfer what you learn in one application to the others because the structure and behavior of all the applications are quite similar.
- “Application-specific tasks” is organized by application and gives instructions on how to perform tasks that are specific to each application.

Overview of basic applications

Date Book



Date Book lets you quickly and easily schedule appointments or any kind of activity associated with a time and date.

In Date Book, you can do the following:

- Enter a description of your appointment and assign it to a specific time and date.
- Display a chart of your appointments for an entire week. The Week View makes it easy to spot available times and any potential scheduling overlaps or conflicts.

- Display a monthly calendar to quickly spot days where you have morning, lunch, or afternoon appointments.
- Display an agenda showing appointments, untimed events, and your To Do items for the day.
- Set an alarm to notify you of the scheduled activity.
- Create reminders for events that are based on a particular date, rather than time of day. Birthdays and anniversaries are easy to track with your handheld.
- Attach notes to individual events for a description or clarification of the entry in your Date Book.

To open Date Book:

- Press the Date Book application button on the front panel of your handheld. Date Book opens to today's schedule.

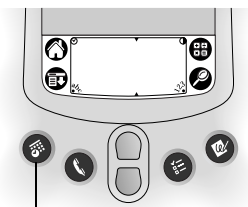

Date Book button

Note: Press the Date Book application button repeatedly to cycle through the Day, Week, Month and Agenda views.

Address Book



Address Book enables you to keep names, addresses, phone numbers, and other information about your personal or business contacts.

In Address Book, you can do the following:

- Quickly look up or enter names, addresses, phone numbers, and other information.
- Enter up to five phone numbers (home, work, fax, mobile, etc.) or e-mail addresses for each name.
- Define which phone number appears in the Address list for each Address Book entry.
- Attach a note to each Address Book entry, in which you can enter additional information about the entry.

- Assign Address Book entries to categories so that you can organize and view them in logical groups.
- Create your own digital business card that you can beam to other Palm OS® handhelds.

To open Address Book:

- Press the Address Book application button on the front panel of your handheld. Address Book opens to display the list of all your records.



Address Book button

Note: Press the Address Book application button repeatedly to cycle through the categories in which you have records. Press and hold the Address Book application button to instantly beam your business card to another Palm OS handheld.

To Do List



To Do List is a convenient place to create reminders and prioritize the things that you have to do.

In To Do List, you can do the following:

- Make a quick and convenient list of things to do.
- Assign a priority level to each task.
- Assign a due date for any or all of your To Do List items.
- Assign To Do List items to categories so that you can organize and view them in logical groups.
- Sort your To Do List items either by due date, priority level, or category.
- Attach notes to individual To Do List items for a description or clarification of the task.

To open To Do List:

- Press the To Do List application button on the front panel of your handheld. To Do List opens to display the category of items you last viewed.

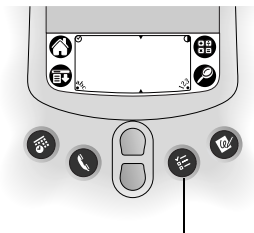

To Do List button

Note: Press the To Do List application button repeatedly to cycle through the categories in which you have items.

Note Pad



Note Pad provides a place to take notes in your own handwriting. You can use Note Pad to do everything you might do with a piece of paper and a pencil.

In Note Pad, you can do the following:

- Take notes, draw a sketch, or write any kind of message directly on your handheld screen. Later, you can enter this information into other applications.
- Set an alarm to use your notes as reminder messages.
- Assign notes to categories so that you can organize and view them in logical groups.
- Copy and paste notes into popular computer applications like Microsoft Word using Palm™ Desktop software and HotSync® technology.

To open Note Pad:

- Press the Note Pad application button on the front panel of your handheld. Note Pad opens a new note so that you can begin writing immediately.

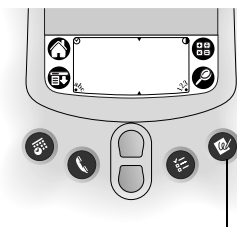

Note Pad button

Note: Press the Note Pad application button repeatedly to cycle through the categories in which you have items.

Memo Pad





Memo Pad provides a place to take notes that are not associated with records in Date Book, Address Book, or To Do List.

In Memo Pad, you can do the following:

- Use Graffiti® characters to store memos, lists, or any other text message on your handheld.
- Drag and drop memos into popular computer applications like Microsoft Word when you synchronize using Palm Desktop software and HotSync technology.
- Assign memos to categories so that you can organize and view them in logical groups.
- Write down phone numbers and other types of information. Later, you can copy and paste this information to other applications.

To open Memo Pad:

1. Tap the Applications icon .
2. Tap the Memo Pad icon .

Calculator



Calculator enables you to perform addition, subtraction, multiplication, division, and square root operations.

In Calculator, you can do the following:

- Perform basic calculations.
- Store and retrieve values.
- Display the last series of calculations, which is useful for confirming a series of “chain” calculations.

To open Calculator:

- Tap the Calculator icon  next to the Graffiti writing area.

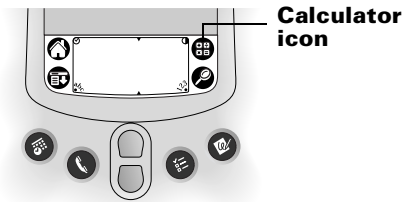



Clock

 Clock enables you to view the current time and date and to set an alarm.

In Clock, you can do the following:

- View the current time and date.
- Open a preferences screen where you can set the time and date for all the applications on your handheld.
- Set an alarm.

To open Clock:

1. Tap the Applications icon .
2. Tap the Clock icon .

Tip: You can also tap the clock icon  in the upper-left corner of the Graffiti writing area to open clock.

Common tasks

The tasks described in this section use the term “records” to refer to an individual item in any of the applications: a single Date Book event, Address Book entry, To Do List item, Note Pad note, or Memo Pad memo.

Creating records

You can use the following procedure to create a new record in Date Book, Address Book, To Do List, Note Pad, and Memo Pad.

To create a record:

1. Select the application in which you want to create a record.
2. Tap New.

3. In Date Book only: Select start and end times for your appointment and tap OK.
4. Enter text for the record.
5. (Optional) To select attributes for the record:
 - In Date Book, Address Book, To Do List, and Memo Pad, tap Details.
 - In Note Pad, tap the Menu icon , and then tap Options and Details.
6. In Address Book, Note Pad, and Memo Pad only: Tap Done.

There's no need to save the record because your handheld saves it automatically.

Editing records

After you create a record, you can change, delete, or enter new text at any time. Two screen features tell you when your handheld is in editing mode:

- A blinking cursor
- One or more dotted edit lines

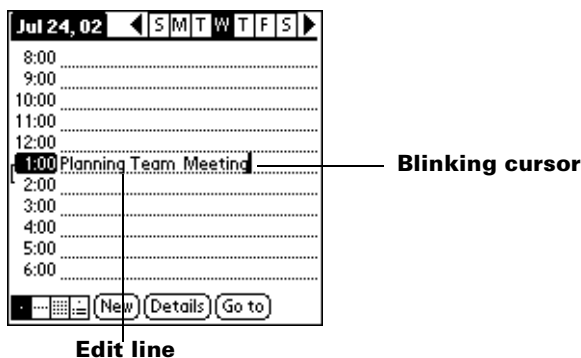

Note: In Note Pad you can write anywhere on the screen. So, you will not see an edit line or blinking cursor.

Entering text

For information on how to enter text using Graffiti writing, the onscreen keyboard, or the keyboard attached to your computer, see Chapter 2. For information on entering text in Note Pad, see "Note Pad" later in this chapter.

Edit menu

The Edit menu is available with any screen where you enter or edit text. In general, commands available in the Edit menu apply to text that you *select* in an application.

To select text in an application:

1. Tap the beginning of the text that you want to select.
2. Drag the stylus over the text to highlight it (in black).

Note: You can also double tap to select a word, or triple tap to select a line of text.

You can also drag *across* the text to select additional words, or drag *down* to select a group of lines.

The following commands may appear in an Edit menu:

Undo	Reverses the action of the <i>last edit</i> command. For example, if you used Cut to remove text, Undo restores the text you removed. Undo also reverses deletions done by using backspace. When the drawing area is selected in Note Pad, Undo erases the last line drawn.
Clear Note	Erases the drawing from a note in Note Pad. Clear Note appears in the Edit menu only when the drawing area is selected.
Cut	Removes the selected text and stores it temporarily in the memory of your handheld. You can paste the text you cut into another area of the current application or into a different application.
Copy	Copies the selected text and stores it temporarily in the memory of your handheld. You can paste the text that you copy into another area of the current application or into a different application.
Paste	Inserts the text that you cut or copied at the selected point in a record. The text you paste replaces any selected text. If you did not previously cut or copy text, Paste does nothing.

- Select All** Selects all of the text in the current record or screen. This enables you to cut or copy all of the text and paste it elsewhere.
- Keyboard** Opens the onscreen keyboard. When you finish with the onscreen keyboard, tap Done.
- Graffiti Help** Opens screens that show all the Graffiti character strokes. Use this command anytime you forget a stroke for a character.

Deleting records

To delete a record:

1. Select the record you want to delete.
2. Tap the Menu icon .
3. Tap Record, and then tap the Delete command:

Date Book: Delete Event

Address Book: Delete Address

To Do List: Delete Item

Note Pad: Delete Note

Memo Pad: Delete Memo

A confirmation dialog box appears. If you want to save a copy of the deleted item to an archive file in Palm Desktop software, be sure that the check box is checked. If you don't want to save a copy, tap the check box to remove the check. (The archive check box does not appear in Note Pad because you can't archive Note Pad notes.)

4. Tap OK.

If you choose to save a copy of the selected item, your handheld transfers it to the archive file on your desktop the next time you perform a HotSync operation.

Other ways to delete records

You can also delete records in the following ways:

- In Date Book, Address Book, To Do List, and Memo Pad, open the Details dialog box for the record, tap Delete, and then tap OK.
- In Note Pad, open the note you want to delete, and then tap Delete.
- Delete the text of the record.

Note: In Date Book, you can choose to delete the text of the current repeating event, current and future events, or all instances of that event.

Purging records

Over time, as you use Date Book and To Do List, you'll accumulate records in these applications that have outlived their usefulness. For example, events that occurred months ago remain in the Date Book, and To Do List items that you marked as completed remain in the list.

All these outdated records take up memory on your handheld, so it's a good idea to remove them by using Purge. If you think Date Book or To Do List records might prove useful later, you can purge them from your handheld and save them in an archive file on your computer.

Purging is not available in Address Book, Note Pad, or Memo Pad; you must delete outdated records manually from these applications.

To purge records:

1. Open the application.
2. Tap the Menu icon .
3. Tap Record, and then tap Purge.

A confirmation dialog box appears.

Date Book: Tap the pick list and select how old a record must be to be purged. Purge deletes repeating events if the last of the series ends before the date that you purge records.

Date Book, To Do List: If you want to save a copy of the purged records to an archive file on your desktop, be sure that the check box is checked. If you don't want to save a copy, tap the check box to remove the check box.

4. Tap OK.

If you chose to save a copy of the purged records, your handheld transfers them to an archive file on your desktop the next time you perform a HotSync operation.

Note: Purging does not happen automatically. You must tap the command to make it happen.

Exchanging and updating data: HotSync operations

The HotSync process automatically synchronizes — that is, exchanges and updates — data between your handheld and Palm Desktop software. Changes you make on your handheld or Palm Desktop software appear in both places after a HotSync operation. HotSync technology synchronizes only the needed portions of files, thus reducing synchronization time.

You can synchronize your data either directly or indirectly. Direct methods include connecting your handheld to the cradle/cable attached to your computer, or using infrared communications. An indirect method is using a modem. See Chapter 6 for information about performing HotSync operations via a modem or IR port.

Performing a HotSync operation for the first time: Windows

The first time you synchronize your data, you need to enter user information on Palm Desktop software. After you enter this information and synchronize, the HotSync Manager recognizes your handheld and doesn't ask for this information again.

If you are a System Administrator preparing several handhelds for a group of users, you may want to create a user profile. See “Creating a user profile” in Chapter 6 before performing the following steps.

Important: You must perform your *first* HotSync operation with a local, direct connection, or with infrared communication, rather than using a modem.

The following steps assume that you have already installed Palm Desktop software. If you have not installed this software, see “Installing Palm Desktop software” in Chapter 1 for instructions.

To perform a local HotSync operation on a Windows computer:

1. Connect your handheld to the cradle/cable.

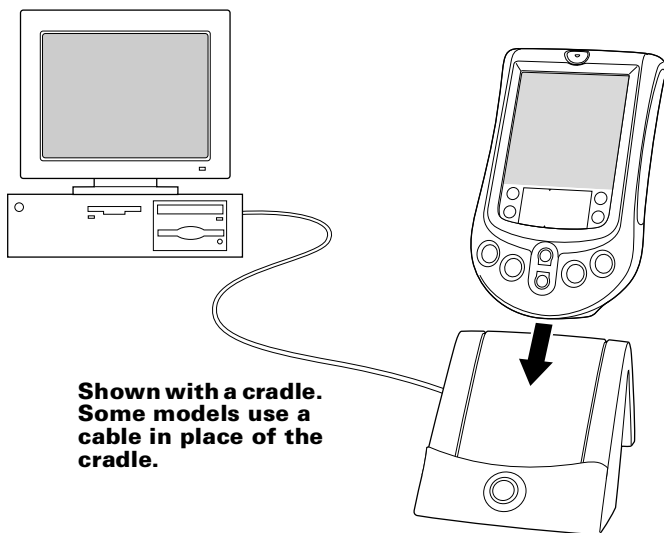

2. If the HotSync Manager is not running, start it: On the Windows desktop, click Start, and then choose Programs. Navigate to the Palm Desktop software program group and choose HotSync Manager. Alternatively, you can start the Palm Desktop software which automatically opens the HotSync Manager.
3. Press the HotSync button ™ on the cradle/cable.

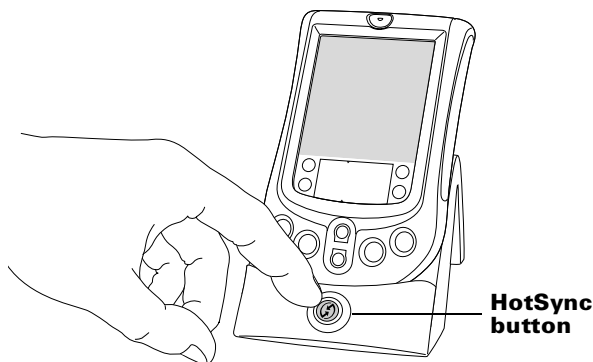

Important: The first time you perform a HotSync operation, you must enter a user name in the New User dialog box and click OK. Every handheld should have a unique name. To prevent loss of a user's records, never try to synchronize more than one handheld to the same user name.

The HotSync Progress dialog box appears and synchronization begins.

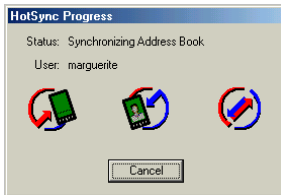

4. Wait for a message on your handheld indicating that the process is complete.

After the HotSync process is complete, you can remove your handheld from the cradle/cable.

Tip: Gently rock your handheld forward in the cradle and then lift it to remove.

Performing a HotSync operation for the first time: Macintosh

When you installed Palm Desktop software, you entered a user name. This user name is the connection between your handheld and your Macintosh.

The first time you perform a HotSync operation the Palm Desktop software:

- Adds a user name to your handheld.
- Creates a folder for the user name in the Users folder inside the Palm folder. For example, if you entered Jane Garcia as your user name, a folder called Jane Garcia is created in the Users folder.

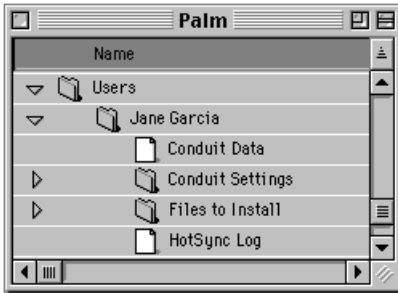

- Creates a file named User Data in your user name folder.

Note: User names appear in the User pop-up on the right side of the toolbar. You can change users by selecting a new name in the pop-up menu.

Each subsequent time you perform a HotSync operation, HotSync Manager reads the user name from your handheld and synchronizes the data in the folder of the same name.

Note: Be sure you select the correct user name from the User pop-up before entering data on Palm Desktop or performing a HotSync operation.

If you are a System Administrator preparing several handhelds for a group of users, you may want to create a user profile. See “Creating a user profile” in Chapter 6 before performing the following steps.

Important: You must perform your *first* HotSync operation with a local, direct connection, or with infrared communication.

The following steps assume that you have already installed Palm Desktop software. See “Palm Desktop software” in Chapter 1 if you have not installed this software.

To perform a local HotSync operation on a Macintosh:

1. Connect your handheld to the cradle/cable.

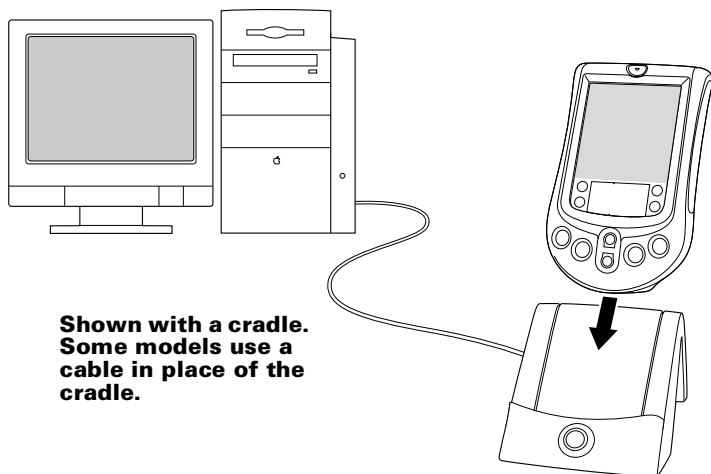

2. Make sure HotSync Manager is enabled: Double-click the HotSync Manager icon in the Palm folder. Click the HotSync Controls tab and make sure the Enabled option is selected.
3. Press the HotSync button  on the cradle/cable.

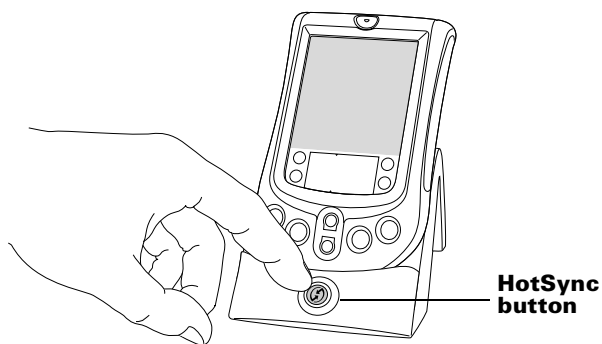

The HotSync Progress dialog box appears followed by the Select User dialog box.

4. In the Select User dialog box, select the user name you entered when you installed the Palm Desktop software, and click OK.

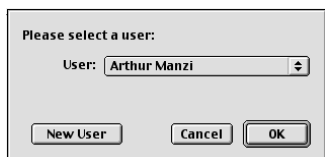

The HotSync Progress dialog box reappears and synchronization begins.



5. Wait for a message on your handheld indicating that the process is complete.

After the HotSync process is complete, you can remove your handheld from the cradle/cable.

Tip: Gently rock your handheld forward in the cradle and then lift it to remove.

Beaming information

Your handheld is equipped with an IR (infrared) port that you can use to beam information to another Palm OS handheld that's close by and also has an IR port. The IR port is located at the top of the handheld, behind the small dark shield.

You can beam the following information between Palm OS handhelds:

- The record currently displayed in Date Book, Address Book, To Do List, Note Pad, or Memo Pad
- All records of the category currently displayed in Address Book, To Do List, Note Pad, or Memo Pad
- A special Address Book record that you designate as your business card, containing information you want to exchange with business contacts
- An application installed in RAM memory
- An application installed on an expansion card that is seated in the card slot

Note: You can also perform HotSync operations using the IR port. See "IR HotSync operations" in Chapter 6 for more details.

To select a business card:

1. Create an Address Book record that contains the information you want on your business card.
2. Tap the Menu icon .
3. Tap Record, and then tap Select Business Card.
4. Tap Yes.

To beam a record, business card, or category of records:

1. Locate the record, business card, or category you want to beam.
2. Tap the Menu icon .
3. Tap Record, and then tap one of the following:
The Beam command for an individual record
In Address Book only: Beam Business Card
Beam Category

Tip: You can also beam a business card by holding down the Address Book application button  until the Beam Status dialog box appears.

4. When the Beam Status dialog box appears, point the IR port directly at the IR port of the receiving handheld.

Tip: For best results, handhelds should be between 10 centimeters (approximately 4 inches) and 1 meter (approximately 39 inches) apart, and the path between the two handhelds must be clear of obstacles. Beaming distance to other Palm OS handhelds may be different.



5. Wait for the Beam Status dialog box to indicate that the transfer is complete before you continue working on your handheld.

To beam an application:

1. Open the Applications Launcher.
2. Tap the Menu icon .
3. Tap App, and then tap Beam.
4. Select either Handheld or Card from the Beam From pick list.

5. Tap the application you want to transfer.

Note: Some applications are copy-protected and cannot be beamed. These are listed with a lock icon next to them.
6. Tap Beam.
7. When the Beam Status dialog box appears, point the IR port directly at the IR port of the receiving handheld.
8. Wait for the Beam Status dialog box to indicate that the transfer is complete before you continue working on your handheld.

To receive beamed information:

1. Turn on your handheld.
2. Point the IR port directly at the IR port of the transmitting handheld to open the Beam dialog box.
3. Select a category for the incoming information, create a new category, or leave the information unfiled.



4. Tap Yes.

Tips on beaming information

- You can set the full-screen pen stroke to beam the current entry. See “Pen preferences” in Chapter 7 for more information.
- You can draw the Graffiti Command stroke to activate the Command toolbar, and then tap the beam icon.

You can use the Graffiti Command stroke “/ B” to beam the current entry.

Categorizing records

Categorize records in the Address Book, To Do List, Note Pad, and Memo Pad applications so that they are grouped logically and are easy to review. (You can also categorize applications. See “Using the Applications Launcher” in Chapter 3 for more information.)

When you create a record, your handheld automatically places it in the category that is currently displayed. If the category is All, your handheld assigns it to the Unfiled category. You can leave an entry as Unfiled or assign it to a category at any time.

System-defined and user-defined categories

By default, your handheld includes system-defined categories, such as All and Unfiled, and user-defined categories, such as Business and Personal.

You cannot modify the system-defined categories, but you can rename and delete the user-defined categories. In addition, you can create your own user-defined categories. You can have a maximum of 15 user-defined categories in each application.

Note: When you have an expansion card properly seated in the expansion card slot, the last item in the category pick list will be the name of the expansion card. You cannot otherwise categorize applications that reside on an expansion card.

Address Book contains the QuickList user-defined category, in which you can store the names, addresses, and phone numbers you might need in emergencies (doctor, fire department, lawyer, etc.).

Note: The illustrations in this section come from Address Book, but you can use these procedures in all the applications in which categories are available.

To move a record into a category:

1. Select the record you want to categorize.
2. In Address Book only: Tap Edit.
In Note Pad only: Tap the Menu icon , and then tap Options.
3. Tap Details.
4. Tap the Category pick list to display the list of available categories.



5. Select the category for the record.
6. Tap OK.

Note: In Address Book, Note Pad, and Memo Pad you can tap the category name in the upper-right corner of the screen and select a new category for the item.

To display a category of records:

1. Tap the category pick list in the upper-right corner of the list screen.

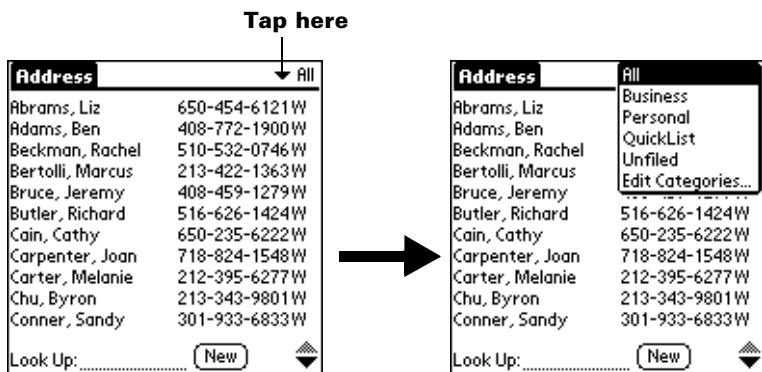

Note: In the Date Book Agenda view, the pick list is in the upper-right corner of the To Do list.

2. Select the category you want to view.

The list screen now displays only the records assigned to that category.

Tip: Pressing an application button on the front panel of the handheld toggles through all the categories of that application.

To define a new category:

1. Tap the category pick list in the upper-right corner of the list screen.

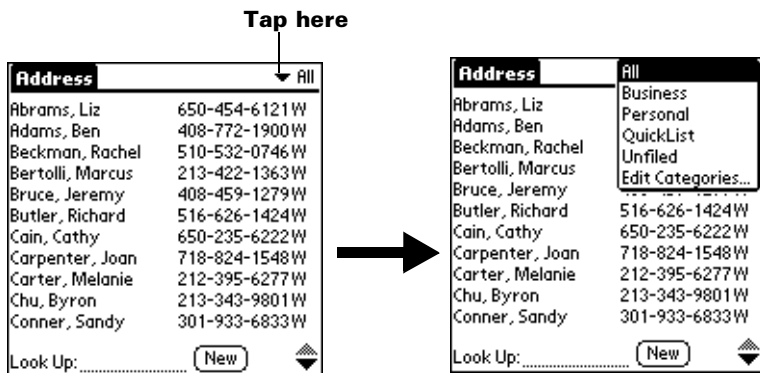

2. Tap Edit Categories.
3. Tap New.



4. Enter the name of the new category, and then tap OK.



5. Tap OK.

You can assign any of your records to the new category.

To rename a category:

1. Tap the category pick list in the upper-right corner of the list screen.
2. Tap Edit Categories.
3. Select the category that you want to rename, and then tap Rename.



4. Enter the new name for the category, and then tap OK.



5. Tap OK.

Tip: You can group the records in two or more categories into one category by giving the categories the same name. For example, if you change the name of the Personal category to Business, all records formerly in the Personal category appear in the Business category.

Finding information

Your handheld offers several ways to find information quickly:

- **All applications that reside on your handheld:** Find locates any text that you specify, always starting with the current application.

Note: Find does not search through applications on expansion cards.

- **Date Book, To Do List, Memo Pad:** Phone Lookup displays the Address list screen and lets you add the information that appears in this list to a record.

- **Address Book:** The Look Up line lets you enter the first letters of a name to scroll immediately to that name.

Looking up Address Book records

When working with Address Book, the scroll button on the front panel of the handheld makes it easy to navigate among your address entries.

- In the Address list screen, the scroll button moves up or down an entire screen of records. If you hold down the scroll button, you accelerate the scrolling and display every third screen.
- In the Address view screen, the scroll button moves to the previous or next address record.

You can also use the Address list Look Up feature to quickly scroll to any of your Address Book entries.

To look up an Address Book record:

1. Display the Address list screen.
2. Enter the first letter of the name you want to find.

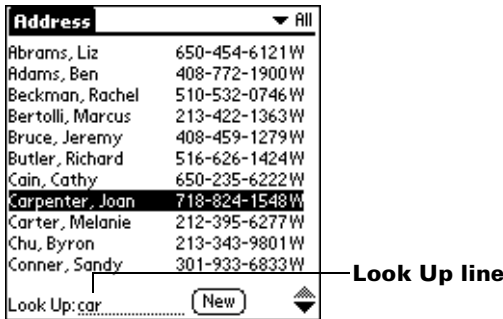

The list scrolls to the first entry that begins with that letter. If you write another letter, the list scrolls to the first entry that starts with those *two* letters. For example, writing an “s” scrolls to “Sands,” and writing “sm” scrolls further to “Smith.” If you sort the list by company name, the Look Up feature scrolls to the first letter of the company name.

3. Tap the record to view its contents.

Using Find

You can use Find to locate any text that you specify, in any application that resides on your handheld. Find does not search applications that reside on an expansion card.

To use Find:

1. Tap the Find icon .

Tip: If you select text in an application before you tap Find, the selected text automatically appears in the Find dialog box.

2. Enter the text that you want to find.

Find is *not* case-sensitive. For example, searching for the name “davidson” also finds “Davidson.”

Find locates any words that begin with the text you enter. For example, searching for “plane” finds “planet,” but not “airplane.”

3. Tap OK.

Find searches for the text in all records and all notes.

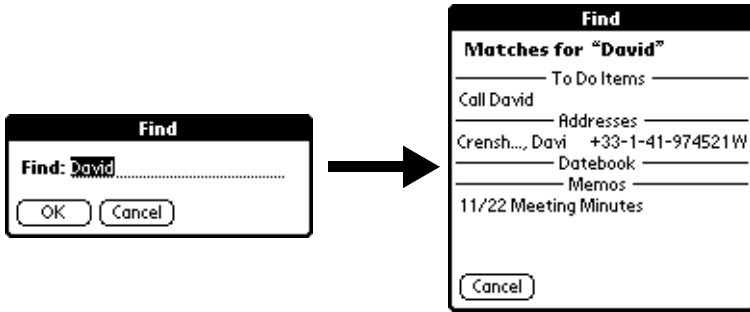

As your handheld searches for the text, you can tap Stop at any time. You may want to do this if the entry you want appears before your handheld finishes the search. To continue the search after you tap Stop, tap Find More.

4. Tap the text that you want to review.

Using Phone Lookup

Phone Lookup displays the Address list screen and lets you add the information that appears in this list to a record.

To use Phone Lookup:

1. Display the record in which you want to insert a phone number. The record can be in Date Book, To Do List, or Memo Pad.
2. Tap the Menu icon .
3. Tap Options, and then tap Phone Lookup.
4. Begin to spell the last name of the name you want to find.

The list scrolls to the first record in the list that starts with the first letter you enter. Continue to spell the name you're looking for, or when you see the name, tap it.



5. Tap Add.

The name you selected, along with the other information associated with it, is pasted into the record you selected in step 1.

Phone Lookup tips

Write the Graffiti Command stroke “/L” to activate the Phone Lookup feature. You can also activate it in the following circumstances:

- **While entering text:** For example, to insert the full name and phone number for someone with the last name “Williams,” write the Graffiti characters for “Wi” and then the Phone Lookup Command stroke “/L.”

Assuming you have only one Address Book record that begins with “Wi,” your handheld inserts the full name “Fred Williams” (and its associated information). If you have more than one name that begins with “Wi,” the Phone Lookup screen appears and highlights the first record that begins with “Wi.”

- **For selected text:** Drag to highlight the text, and then write the Phone Lookup Command stroke “/L.” Your handheld replaces the selected text and adds the name and its associated information.

Sorting lists of records

You can sort lists of records in various ways, depending on the application. Sorting is available in applications that have list screens: Address Book, To Do List, and Memo Pad.

Note: You can also assign records to categories. See “Categorizing records” earlier in this chapter.

To sort records in To Do List:

1. Open the application to display the list screen.
2. Tap Show.
3. Tap the Sort by pick list and select an option.
4. Tap OK.

To sort records in Address Book, Note Pad, and Memo Pad:

1. Open the application.
2. In Note Pad only: Tap Done to display the list screen.
3. Tap the Menu icon .
4. Tap Options, and then tap Preferences.

Address Book:



Note Pad:

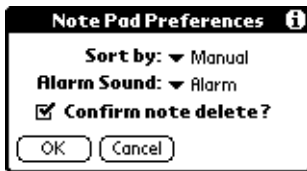

Memo Pad:

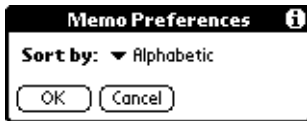

5. Do one of the following:

Address Book: Tap the setting you want.

Note Pad: Tap the Sort by pick list and select Alphabetic, Date, or Manual.

Memo Pad: Tap the Sort by pick list and select Alphabetic or Manual.

6. Tap OK.

To sort the Note Pad or Memo list manually, tap and drag a memo or note to a new location in the list.

Note: To make the list of your memos appear in Palm Desktop software as you manually sorted it on your handheld, open Memo Pad in Palm Desktop software and click List by. Then select Order on handheld.

Making records private

You can make individual records private. Private records remain visible and accessible, however, until you select the Security setting to hide or mask all private records. See “Security” in Chapter 3 for more information.

Hiding or masking private records

You can hide or mask all records that you mark as private. Masked records appear as grey placeholders in the same position they would appear if they were not masked, and are marked with a lock icon. Hidden records disappear completely from the screen. If you define a password for your handheld, you must enter it to display private records.

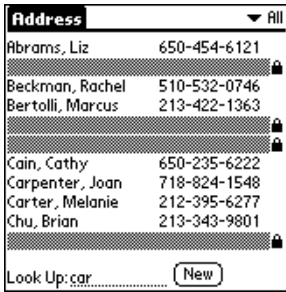

To hide all private records:

1. Tap the Applications icon .
2. Tap Security.
3. Tap the Current Privacy pick list and select Hide Records.

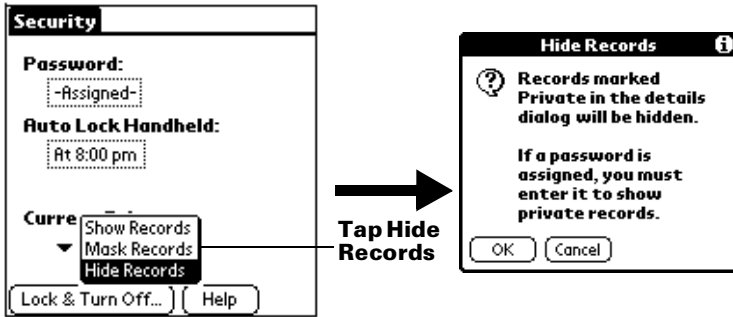

4. Tap OK to confirm that you want to hide private records.

To mask all private records:

1. Tap the Applications icon .
2. Tap Security.
3. Tap the Current Privacy pick list and select Mask Records.

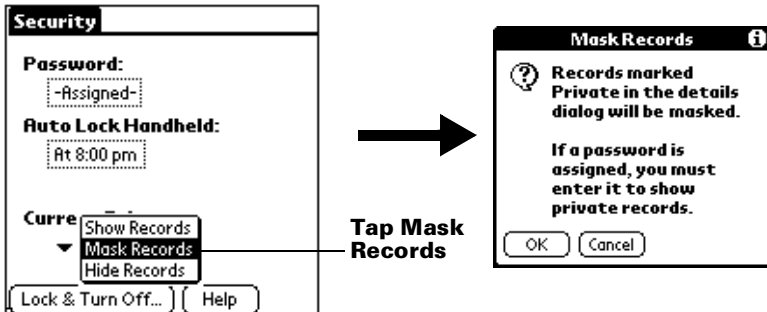

4. Tap OK to confirm that you want to mask private records.

To display all private records:

1. Do one of the following:

Tap the Applications icon , tap Security, then tap the Current Privacy pick list and select Show Records.

If you do not have a password, hidden and masked records become visible.

If you have a password, the Show Private Records dialog box appears. Go to step 2.

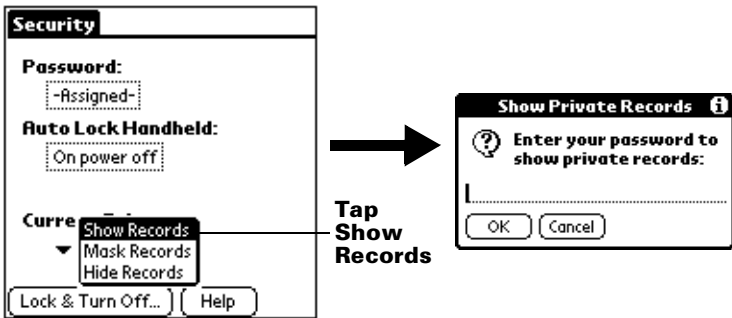

2. Enter your password, and then tap OK.

To unmask individual records:

1. Tap a masked record.
2. Do one of the following:

If you do not have a password, a masked record becomes visible.

If you have a password, the Show Private Records dialog box appears. Go to step 3.

3. Enter your password, and then tap OK.

To make a record private:

1. Display the entry that you want to make private.
2. In Note Pad only: Tap the Menu icon , and then tap Options.
3. Tap Details.
4. Tap the Private check box to select it.
5. Tap OK.

Attaching notes

In applications except Memo Pad and Note Pad, you can attach a note to a record. A note can be up to several thousand characters long. For example, for an appointment in Date Book, you can attach a note with directions to the location.

To attach a note to a record:

1. Display the entry to which you want to add a note.
2. In Address Book only: Tap Edit.
3. Tap Details.
4. Tap Note.
5. Enter your note.
6. Tap Done.

A small note icon appears at the right side of any item that has a note.

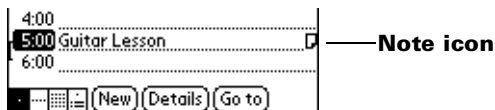

To review or edit a note:

- Tap the Note icon .

To delete a note:

1. Tap the Note icon .
2. Tap Delete.
3. Tap Yes.

Choosing fonts

In all basic applications, you can change the font style to make text easier to read. You can choose a different font style for each application.

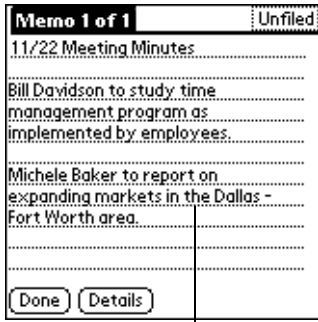

Small font



Large font

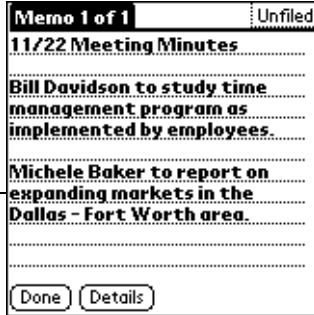

Bold font

To change the font style:

1. Open an application.
2. Tap the Menu icon .
3. Tap Options, and then tap Font.
4. Tap the font style you want to use.

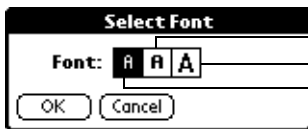

Tap here for bold font

Tap here for large font

Tap here for small font

5. Tap OK.

Reviewing Reminders

You can set alarms to notify you of appointments, notes, and alarms in Date Book, Note Pad, and Clock. When an alarm occurs, your handheld displays a reminder message. If you tap Snooze in response to an alarm message, your handheld reminds you of the alarm again in five minutes. The Reminder screen displays alarms that await attention.



To respond to reminders, do one of the following:

1. Select an item's check box to clear the item.
2. Tap an item (either the icon or the text description) to open the application where the alarm was set. The application opens to the entry associated with the alarm.
3. Tap Done to close the reminder list and return to the current screen. An attention indicator will blink in the upper-left corner of the screen; tap it to view the reminder list again.
4. Tap Snooze to see the list again in five minutes.
5. Tap Clear All to dismiss all reminders in the list.

Note: If you tap Done or Snooze and view the reminder list later, the current time displays in the Reminder bar and the original alarm time displays with each list item.

Application-specific tasks

Date Book

When you open Date Book, the screen shows the current date and a list of times for a normal business day.

Scheduling an event

A record in Date Book is called an “event.” An event can be any kind of activity that you associate with a day. You can enter a new event on any of the available time lines.

When you schedule an event, its description appears on the time line, and its duration is automatically set to one hour. You can easily change the start time and duration for any event.

Note: It’s possible to schedule events that overlap, but Date Book makes it easy to find such conflicts. See “Spotting event conflicts” later in this chapter.

You can also schedule events in your Date Book that occur on a particular date but have no specific start or end times, such as birthdays, holidays, and anniversaries. These are referred to as “untimed events.” Untimed events appear at the top of the list of times, marked with a diamond. You can have more than one untimed event on a particular date.

You can also schedule a repeating event, such as a weekly meeting, and continuous events, such as a three-day conference or a vacation.

To schedule an event for the current day:

1. Tap the time line that corresponds to the beginning of the event.

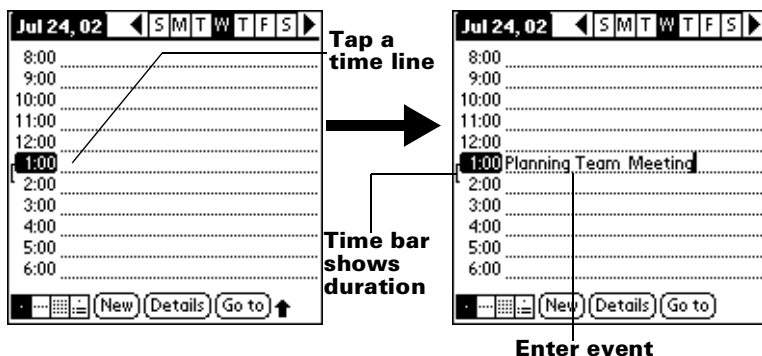

2. Enter a description of the event. You can enter up to 255 characters.
3. If the event is one hour long, skip to step 5. If the event is longer or shorter than an hour, tap the time of the event to open the Set Time dialog box.

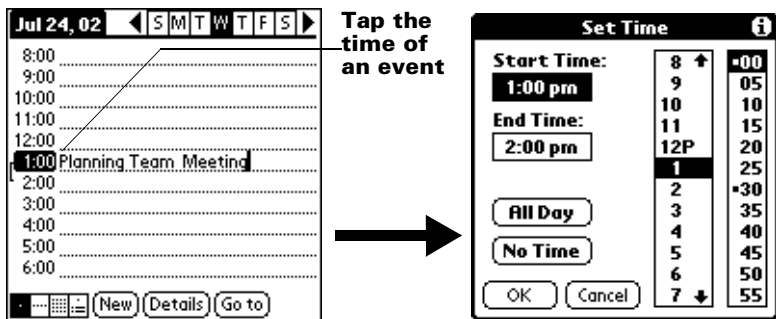

Tip: You can also open the Set Time dialog (to select a start time) by making sure no event is selected, and then writing a number on the number side of the Graffiti writing area.

4. Do one of the following:
 - Tap the time columns on the right side of the Set Time dialog to set the Start Time, then tap the End Time box and tap the time columns to set the End Time.

Tap All Day to automatically insert the start and end time of the event as defined in your Date Book preferences.

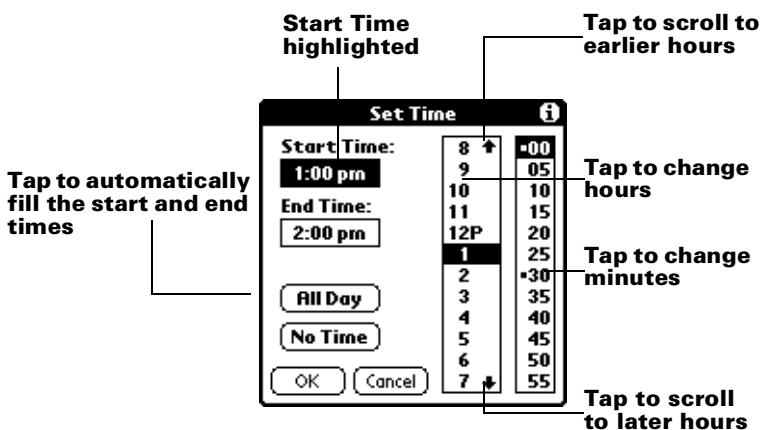

5. Tap OK.

6. Tap a blank area of the screen to deselect the event. A vertical line appears next to the time, indicating the duration of the event.

Note: If an event has the same start and end time, the time is only displayed once.

To schedule an event for another day:

1. Select the date you want for the event by doing one of the following:
 - Tap the day of the week that you want in the date bar at the top of the screen. If necessary, tap the Previous week or Next week scroll arrows to move to another week.

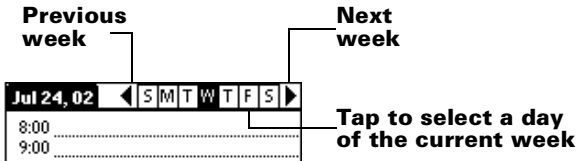

Tip: You can also use the scroll button on the front panel of your handheld to move forward or backward one day at a time.

- Tap Go To at the bottom of the screen to open the Go to Date dialog box. Select a date by tapping a year, month, and day in the calendar.

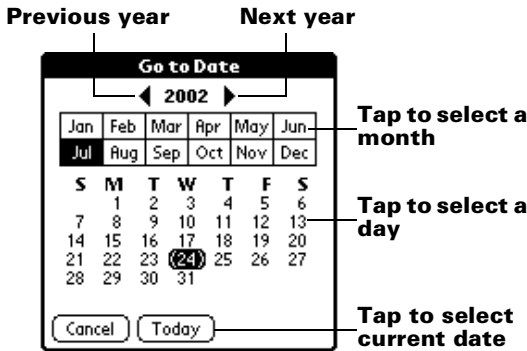

Tip: In the Go to Date dialog box, you can also use the scroll button on the front panel of the handheld to move forward or backward one month at a time.

2. After you locate the date, follow the steps for scheduling an event for the current day.

To schedule an untimed event:

1. Select the date that you want for the event as described in “To schedule an event for another day.”
2. Tap New.
3. Tap No Time, so that no start or end times are defined for the new event.

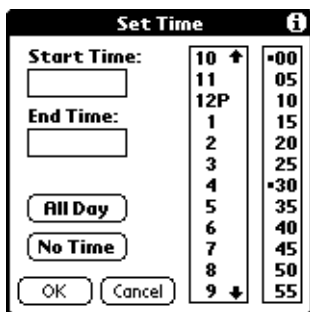

Tip: You can also create a new untimed event by making sure no event is selected and then writing letters in the Graffiti writing area.

4. Enter a description of the event.

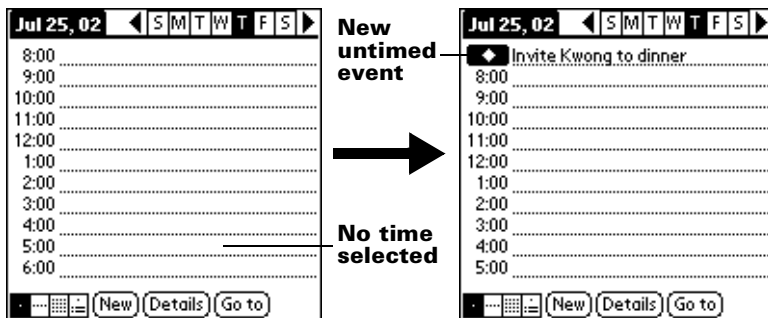

5. Tap a blank area on the screen to deselect the untimed event.

Note: If you create an event and decide later that there is no particular start or end time, you can easily change it to an untimed event. Tap the time of the event in the Date Book screen, tap No Time, and then tap OK.

Rescheduling an event

You can easily make changes to your schedule with your handheld.

To reschedule an event:

1. Tap the event you want to reschedule.
2. Tap Details.
3. To change the time, tap the Time box and select a new time.
4. To change the date, tap the Date box and select a new date.
5. Tap OK.

Setting an alarm for an event

The Alarm setting enables you to set an alarm for events in your Date Book. You can set an alarm to notify you minutes, hours, or days before an event. The default Alarm setting is 5 minutes before the time of the event, but you can change this to any number of minutes, hours, or days.

When you set an alarm, this icon  appears to the far right of the event with the alarm. When the alarm occurs, a reminder message also appears onscreen.

To set an alarm for an event:

1. Tap the event to which you want to assign an alarm.
2. Tap Details.
3. Tap the Alarm check box to select it.
The default setting, 5 Minutes, appears.
4. Tap the pick list to select Minutes, Hours, or Days.
5. Select the 5 and enter any number from 0 to 99 (inclusive) as the number of time units.

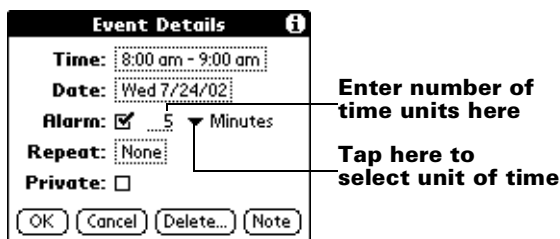

6. Tap OK.

7. When the reminder message appears on screen, do one of the following:

Tap OK to permanently dismiss the reminder and return to the current screen.

Tap Snooze to dismiss the reminder and return to the current screen. The reminder message appears again five minutes after you tap Snooze, and an attention indicator blinks in the upper-left corner of the screen to remind you of the pending alarm.

Tap Go To to open Date Book. Date Book will open and display the event associated with the alarm.

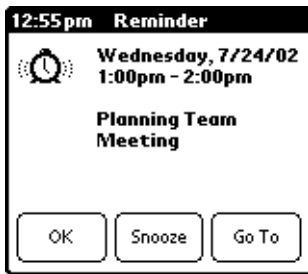

Alarm for untimed events: You can set a silent alarm for an untimed event. In this case, the alarm triggers at the specified period of minutes, hours, or days before midnight (beginning) of the day of the untimed event. When the alarm triggers, the reminder list displays the alarm message until you clear it. See “Reviewing Reminders” in this chapter for details.

For example, you set an alarm for an untimed event that occurs on February 4th. If the alarm is set for 5 minutes, the reminder message appears at 11:55 PM on the night of February 3rd. The reminder remains in the reminder list until you turn on your handheld and dismiss it.

Scheduling repeating or continuous events

The Repeat function lets you schedule events that recur at regular intervals or extend over a period of consecutive days.

A birthday is a good example of an event that repeats annually. Another example is a weekly guitar lesson that falls on the same day of the week and the same time of day.

A business trip or a vacation is an example of a continuous event.

To schedule a repeating or continuous event:

1. Tap the event.
2. Tap Details.
3. Tap the Repeat box to open the Change Repeat dialog box.

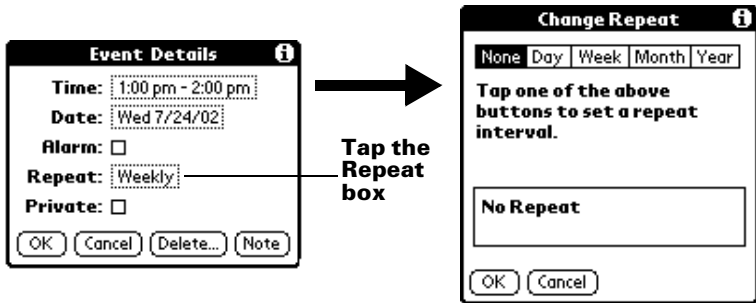

4. Tap Day, Week, Month, or Year to set how often event repeats.
For a continuous event, tap Day.
5. Enter a number that corresponds to how often you want the event to repeat on the Every line.
For example, if you select Month and enter the number 2, the event repeats every other month.
6. To specify an end date for the repeating or continuous event, tap the End on pick list and tap Choose Date. Use the date picker to select an end date.
7. Tap OK.

After you schedule a repeating or continuous event, this icon  appears to the far right of the event.

Changing repeating or continuous events

When you make changes to a repeating or continuous event, such as deleting or adding notes, or changing the time of an event, you can decide which of the events you want to change; all events in the series, just the current event, or the current and future events.

To delete repeating events:

1. Select the record you want to delete.
2. Tap the Menu icon .
3. Tap Record, and then tap Delete Event.

4. Do one of the following:



Tap Current to delete only the current event item.

Tap Future to delete the current and all future event items and reset the end date of the repeating event to the last shown date.

Tap All to delete all occurrences of the repeating event.

5. Tap OK.

Considerations for repeating or continuous events: Keep the following points in mind.

- If you change the start date of a repeating event, your handheld calculates the number of days you moved the event. Your handheld then automatically changes the end date to maintain the duration of the repeating event.
- If you change the repeat interval (e.g., daily to weekly) of a repeating event, past occurrences (prior to the day on which you change the setting) are not changed, and your handheld creates a new repeating event.
- If you change the date of an occurrence of a repeating event (e.g., from January 14th to January 15th) and apply the change to all occurrences, the new date becomes the start date of the repeating event. Your handheld adjusts the end date to maintain the duration of the event. If you apply the change to current and future occurrences, past occurrences are not changed.
- If you change other repeat settings (e.g., time, alarm, private) of a repeating event and apply the change to all occurrences, your handheld creates a new event. The start date of this new event is the day on which the setting is changed.
- If you apply a change to a single occurrence of a repeating event (e.g., time), that occurrence no longer shows the Repeat icon .

Changing the Date Book view

In addition to displaying the time list for a specific day, you can also display a whole week, a month, or an agenda. You can also display the current time.

To cycle through Day, Week, Month, and Agenda views:

- Press the Date Book application button repeatedly to display the next view.
- Tap on the appropriate view icon in the lower-left corner of Date Book.

To display the current time:

1. Tap and hold the stylus on the date bar to display the current time.

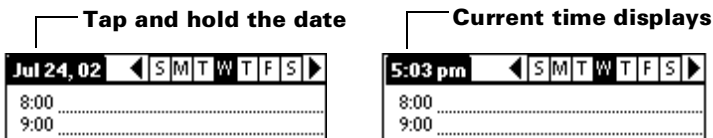

2. Drag the stylus below the title area and then lift it to redisplay the date.

Note: You can also tap the Clock icon ⌚ in the upper left corner of the Graffiti writing area to display the time for a few seconds.

Working in Week View

Week View shows the calendar of your events for an entire week. This view lets you quickly review your appointments and available time slots. In addition, the graphical display helps you spot overlaps and conflicts in your schedule.

To display the Week View:

1. Tap the Week View button.



2. Tap the navigation controls to move forward or backward a week at a time, or tap on a column to display details of an event.

Note: The Week View also shows untimed events and events that are before and after the range of times shown.

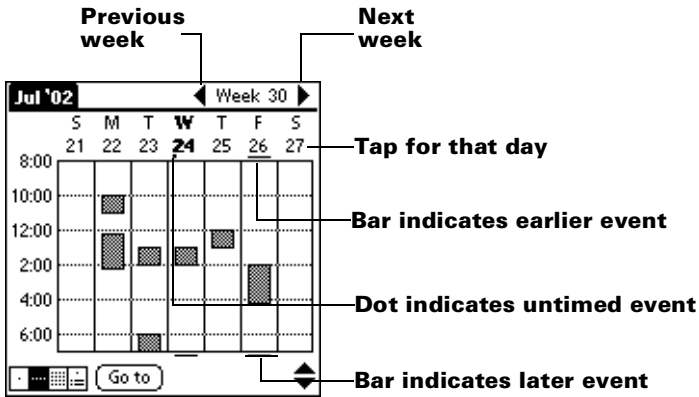

3. Tap an event to show a description of the event.

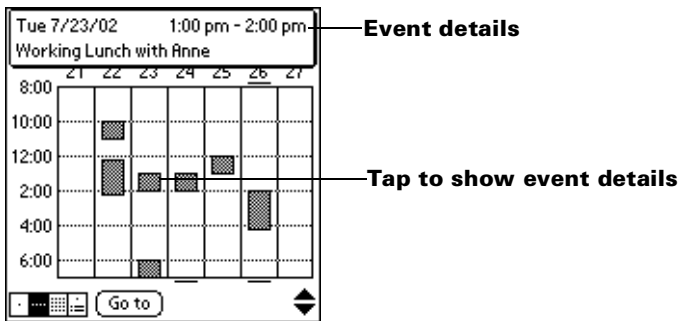

Tips for using Week View: Keep the following points in mind.

- To reschedule an event, tap and drag the event to a different time or day.
- Tap a blank time on any day to move to that day and have the time selected for a new event.
- Tap any day or date that appears at the top of the Week View to move directly to that day without selecting an event.
- The Week View shows the time span defined by the Start Time and End Time in the Date Book Preferences settings. If you have an event before or after this time span, a bar appears at the top or bottom of that day's column. Use the onscreen scroll arrows  to scroll to the event.

Spotting event conflicts

With the ability to define specific start and end times for any event, it's possible to schedule events that overlap (an event that starts before a previous event finishes).

An event conflict (time overlap) appears in the Week View as overlapping bars. The Day View displays overlapping brackets to the left of the conflicting times.

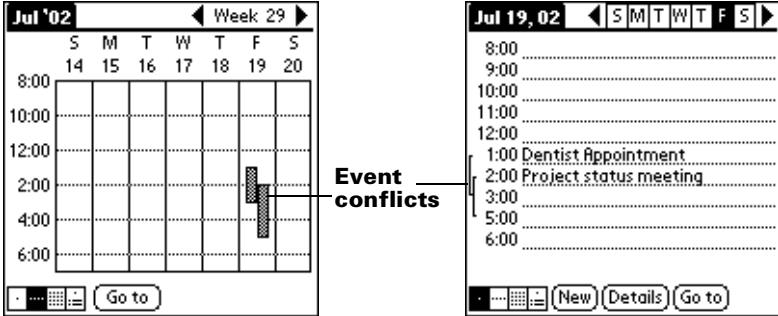

Working in Month View

The Month View screen shows which days have events scheduled. Dots and lines in the Month View indicate events, repeating events, and untimed events.

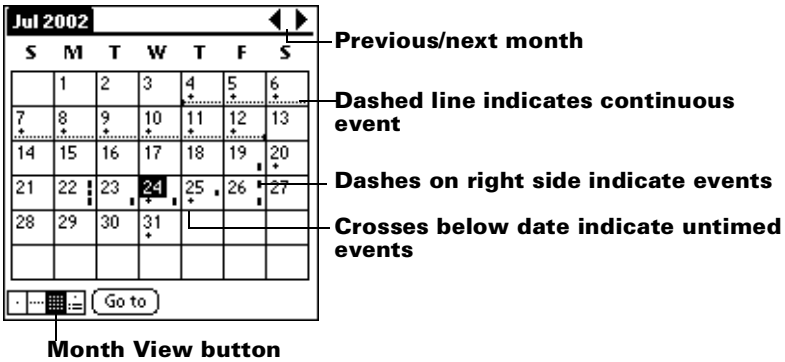

You can control the dots and lines that appear in the Month View. See "Options menu" later in this chapter.

Tips for using Month View: Keep the following points in mind.

- Tap a day in the Month View to display that day in the Day View.
- Tap the scroll arrows in the upper-right corner to move forward or backward a month.
- Tap Go to open the date selector and select a different month.
- Use the scroll button on the front panel of your handheld to move between months. Press the upper half of the button to display the previous month, the lower half to display the next month.

Working in Agenda View

The Agenda view shows you your untimed events, appointments, and To Do items in one screen. When you tap on an untimed event or appointment in the Agenda view, the Day view appears so you can see more detailed information about the event. You can tap the check box next to a To Do item to mark it as completed. When you tap on a To Do item, your To Do list appears.

Note: The To Do items that appear and how you can change them depends on the settings in your To Do preferences. See “To Do Show Options” later in this chapter for more information.

To display the Agenda View:

1. Tap the Agenda View button.



2. Tap the navigation controls to move forward or backward a day at a time, or to display more events and To Do items.

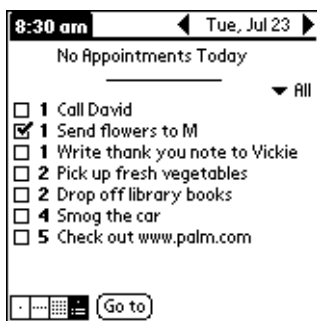
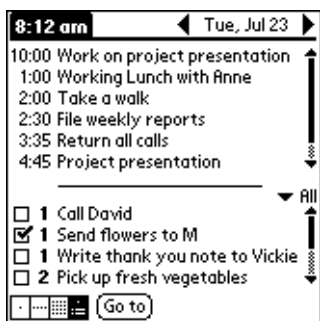

Note: You can also change the category of To Do items shown. Click on the pick list to choose another category.

See “To Do List” for more information on working with To Do items.

Date Book menus, preferences, and display options

Date Book menus are shown here for your reference, and Date Book features that are not explained elsewhere in this book are described here.

See “Using menus” in Chapter 1 for information about choosing menu commands.

Record menu

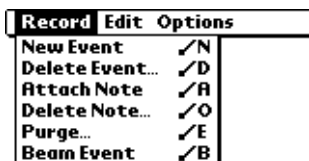

Options menu

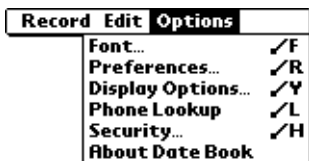

Display Options

Allows you to change Date Book's appearance and which events display.



- **Show Time Bars.** Activates the time bars that appear in the Day View. The time bars show the duration of an event and illustrate event conflicts.
- **Compress Day View.** Controls how times appear in the Day View. When Compress Day View is off, all time slots display. When it is on, start and end times display for each event, but blank time slots toward the bottom of the screen disappear to minimize scrolling.
- **Month View settings.** These check boxes apply to the Month View of the Date Book. You can activate any or all of these settings to show that you have Timed, Untimed, or Daily Repeating events in the Month View *only*.

Preferences



- **Start/End Time.** Defines the start and end times for Date Book screens. If the time slots you select do not fit on one screen, you can tap the scroll arrows  to scroll up and down.
- **Alarm Preset.** Automatically sets an alarm for each new event. The silent alarm for untimed events is defined by minutes, days, or hours before midnight of the date of the event.
- **Alarm Sound.** Sets the tone of the alarm.
- **Remind Me.** Defines how many times the alarm will occur after the initial occurrence. The choices are Once, Twice, 3 Times, 5 Times, and 10 Times.
- **Play Every.** Defines how often the alarm sounds. The choices are Minute, 5 minutes, 10 minutes, and 30 minutes.

About Date Book

Shows version information for Date Book.

Address Book

Address Book is the application in which you store name and address information about people or businesses.

Creating an Address Book entry

A record in Address Book is called an “entry.” You can create entries on your handheld, or you can use Palm Desktop software to create entries on your computer and then download the entries to your handheld with your next HotSync operation.

Palm Desktop software also has data import capabilities that enable you to load database files into Address Book on your handheld.

See “Importing data” in Chapter 2 and Palm Desktop online Help for more information.

To create a new Address Book entry:

1. Press the Address Book application button  on the front of your handheld to display the Address list.
2. Tap New.

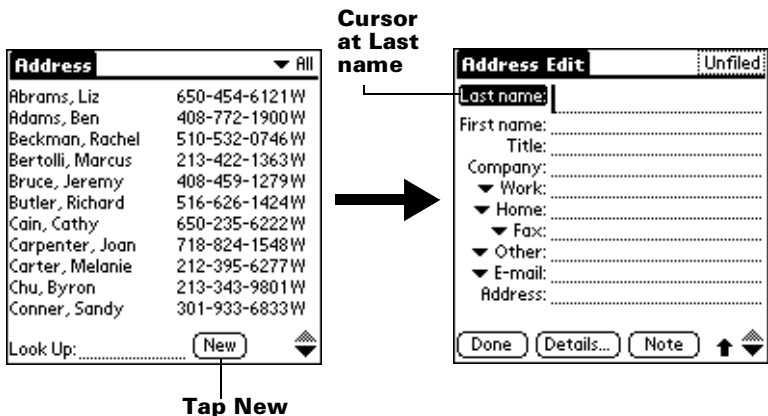

3. Enter the last name of the person you want to add to your Address Book.

Note: The handheld automatically capitalizes the first letter of each field (except numeric and e-mail fields). You do not have to use the Graffiti capital stroke to capitalize the first letter of the name.

4. Use the Next Field Graffiti stroke to move to the First Name field.



Tip: You can also move to any field by tapping it directly.

5. Enter the person’s first name in the First Name field.
6. Enter the other information that you want to include in this entry.

Note: As you enter letters in the Title, Company, City, and State fields, text appears for the first logical match that exists in your Address Book. As you enter more letters, a closer match appears. For example, you may already have Sacramento and San Francisco in your Address Book. As you enter “S” Sacramento appears, and as you continue entering “a” and “n” San Francisco replaces Sacramento. As soon as the word you want appears, tap in the next field to accept the word.

7. Tap the scroll arrows  to move to the next page of information.
8. After you finish entering information, tap Done.



Tap Done

Tip: To create an entry that always appears at the top of the Address list, begin the Last name or Company field with a symbol, as in *If Found Call*. This entry can contain contact information in case you lose your handheld.

Selecting types of phone numbers

You can select the types of phone numbers or e-mail addresses that you associate with an Address Book entry. Any changes you make apply only to the current entry.

To select other types of phone numbers in an entry:

1. Tap the entry that you want to change.
2. Tap Edit.
3. Tap the pick list next to the label you want to change.

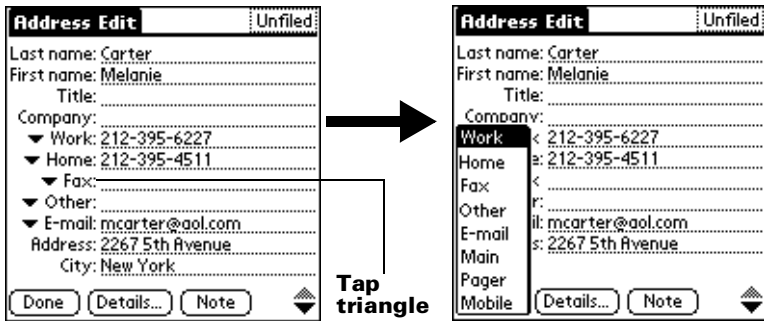

4. Select a new label.

Changing Address Entry details

The Address Entry Details dialog box provides a variety of options that you can associate with an entry.

To open the Address Entry Details dialog box:

1. Tap the entry whose details you want to change.
2. Tap Edit.
3. Tap Details.



4. Select any of the following settings:

Show in List Select which type of phone or other information appears in the Address list screen. Your options are Work, Home, Fax, Other, E-mail, Main, Pager, and Mobile. The identifying letters W, H, F, O, M, or P appear next to the record in the Address list, depending on which information is displayed. If you select E-mail, no identifying letter is displayed.

Category Assign the entry to a category.

Private Hide this entry when Security is turned on.

Address Book menus

Address Book menus are shown here for your reference, and Address Book features that are not explained elsewhere in this book are described here.

See “Using menus” in Chapter 1 for information about choosing menu commands.

The Record and Options menus differ depending on whether you’re displaying the Address list screen or the Address view screen.

Record menus

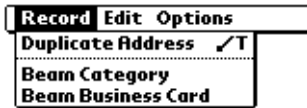

Address list



Address view

Duplicate Address

Makes a copy of the current record and displays the copy in Address Edit so you can make changes to the copied record. The copy has the same category and attached notes as the original record.

Options menus



Address list



Address view

Preferences



- **Remember last category.** Determines how Address Book appears when you return to it from another application. If you select this check box, Address Book shows the last category you selected. If you clear it, Address Book displays the All category.

Rename Custom Fields

These custom fields appear at the end of the Address Edit screen. Rename them to identify the kind of information you enter in them. The names you give the custom fields appear in all entries.



About Address Book

Shows version information for Address Book.

To Do List

A To Do List item is a reminder of some task that you have to complete. A record in To Do List is called an “item.”

To create a To Do List item:

1. Press the To Do List application button  on the front of your handheld to display the To Do List.
2. Tap New.

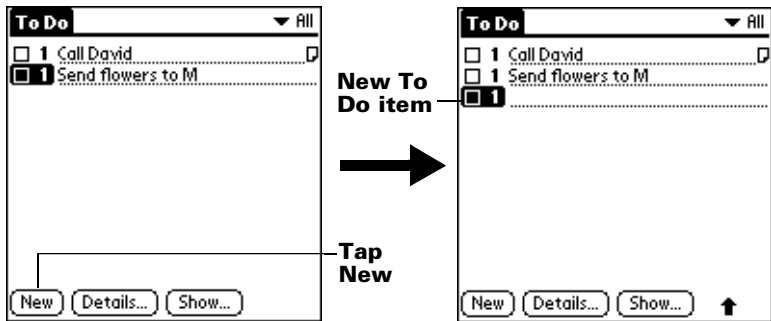

3. Enter the text of the To Do List item. The text can be longer than one line.
4. Tap anywhere onscreen to deselect the To Do List item.

Tip: If no To Do List item is currently selected, writing in the Graffiti writing area automatically creates a new item.

Setting priority

The priority setting for items lets you arrange the tasks in your To Do List according to their importance or urgency. The default setting for the To Do List is to arrange items by priority and due date, with priority 1 items at the top. If you have a number of items in your list, changing an item’s priority setting may move its position in the list.

Note: When you create a new To Do List item, its priority is automatically set to level 1, the highest (most important) level. If you select another item first, however, the item you create appears beneath the selected item and is given the same priority as the selected item.

To set the priority of a To Do List item:

1. Tap the Priority number on the left side of the To Do List item.

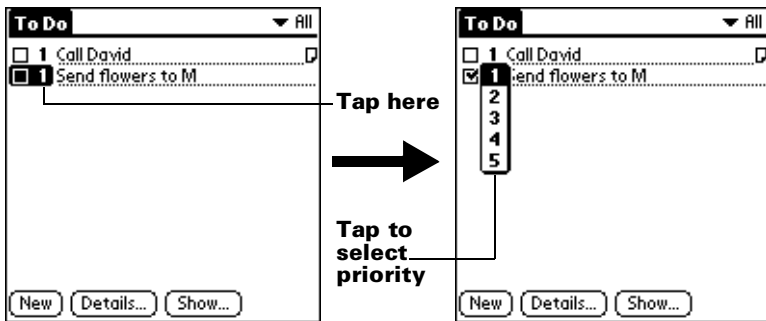

2. Tap the Priority number that you want to set (1 is most important).

Checking off a To Do List item

You can check off a To Do List item to indicate that you've completed it. You can set the To Do List to record the date that you complete the To Do item, and you can choose to show or hide completed items. See "To Do Show Options" later in this chapter.

To check off a To Do List item:

- Tap the check box on the left side of the item.

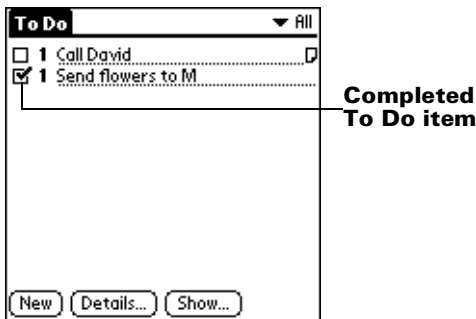

Changing To Do List item details

The To Do Item Details dialog box enables you to change settings for individual items.

To display the To Do Item Details dialog box:

1. Tap the text of the item whose details you want to change.

2. Tap Details.



Setting a due date

You can associate a due date with any To Do List item. You can also sort the items that appear in the list based on their due date.

To set a due date for a To Do List item:

1. In the Details dialog box, tap “No Date” to open the Due Date pick list.

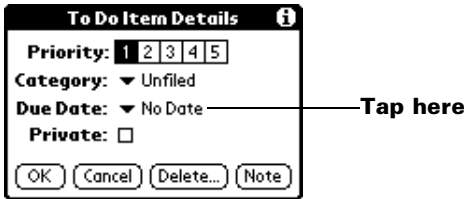

2. Tap the date that you want to assign the item:

Today	Assigns the current date.
Tomorrow	Assigns tomorrow’s date.
One week later	Assigns the date exactly one week from the current date.
No Date	Removes the due date from the item.
Choose date	Opens the date selector, where you can choose any date that you want for the item.

3. Tap OK.

Tip: If you turn on the Show Due Dates option in the To Do Show options dialog, you can tap directly on the due date in the To Do List to open the pick list shown in step 2.

To Do Show Options

The Show Options dialog box enables you to control the appearance of To Do List and To Do items in Date Book Agenda view.

To change the Show Options settings:

1. In To Do List, tap Show.



2. Select any of the following settings:

Show Completed Items

Displays your completed items in the To Do List. If you turn off this setting, your To Do items disappear from the list when you complete (check) them.

Items that no longer appear on the list because you turn off this setting have not been deleted. They are still in the memory of your handheld. Purge completed items to remove them from memory.

Show Only Due Items

Shows only the items that are currently due, past due, or have no due date specified. When this setting is active, items that are not yet due do not appear in the list until their due date.

Record Completion Date

Replaces the due date with the actual date when you complete (check) the item. If you do not assign a due date to an item, the completion date still records when you complete the item.

Show Due Dates

Displays the due dates associated with items in the To Do List and displays an exclamation mark next to items that remain incomplete after the due date passes.

**Show
Priorities**

Shows the priority setting for each item.

**Show
Categories**

Shows the category for each item.

3. Tap OK.

To Do List menus

To Do List menus are shown here for your reference, and To Do List features that are not explained elsewhere in this book are described here.

See “Using menus” in Chapter 1 for information about choosing menu commands.

Record menu

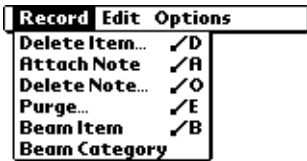

Options menu



**About To Do
List**

Shows version information for To Do List.

Note Pad

A record in Note Pad is called a “note.” You can assign each note a title and store as many notes as permitted by the memory available on your handheld.

To create a new note:

1. Press the Note Pad application button  on the front panel of your handheld to open a new note.

Note: If Note Pad is already running, tap New.

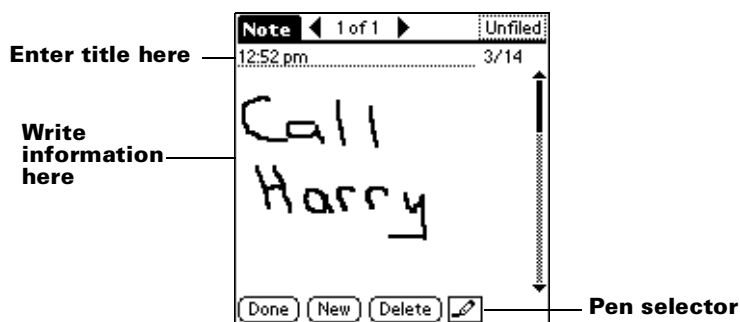

2. Write the information directly on the handheld screen.
Tip: Tap the pen selector to choose a different pen width, or choose the eraser to remove unwanted strokes.
3. (Optional) Select the time at the top of the screen and enter a title using Graffiti writing.
4. Tap Done.

Reviewing notes

The note title and the date you created the note appear in the Note Pad list. If you did not assign a title to your note, the time you created the note appears as the note title. This makes it easy to locate and review your notes.

To review a note:

1. In the Note Pad list, tap the note title.

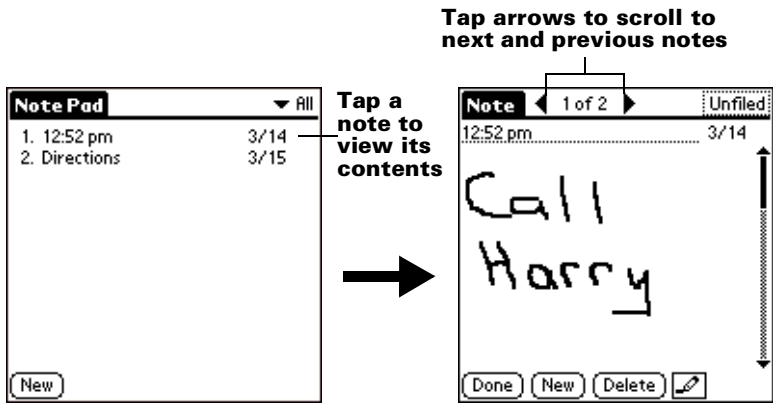

2. Review or edit the contents of the note.
3. Tap Done.

Clearing a note

You can erase the drawing area in a note while retaining the note title.

To clear a note:

1. In the Note Pad list, tap the note title.
2. Tap the Menu icon .
3. Tap Edit, and then tap Clear Note.

Setting an alarm for a note

You can set an alarm for a specific time and date to remind you to follow-up on a note.

To set an alarm for a note:

1. Tap the note to which you want to assign an alarm.
2. Tap the Menu icon .
3. Tap Options, and then tap Alarm.
4. Tap the Time box.

- Tap the hour and minute columns to select the time you want the alarm to occur.

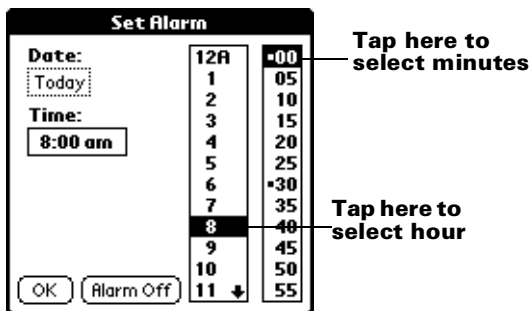

- Tap the Date box.

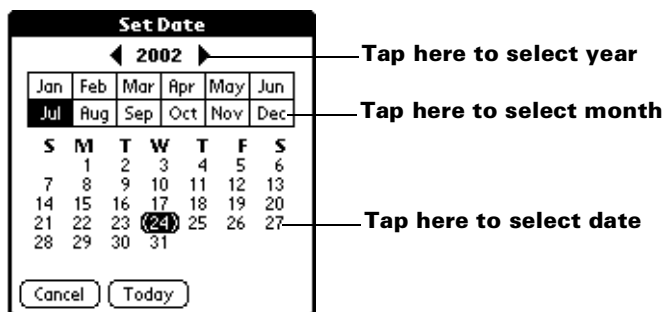

- Tap the year, month, and date you want the alarm to sound. After you tap the date, the Set Alarm dialog box reappears.
- Tap OK.
- When the alarm goes off and the reminder message appears on screen, do one of the following:

Tap OK to permanently dismiss the reminder and return to the current screen.

Tap Snooze to dismiss the reminder and return to the current screen. The reminder message appears again in five minutes, and an attention indicator blinks in the upper-left corner of the screen to remind you of the pending alarm. When the reminder message reappears, the current time displays in the Reminder bar and the note title displays on the screen.

Note: If you did not title the note, the time the note was created displays on the screen.

Tap Go To to open Note Pad. Note Pad will open and display the note associated with the alarm.



Note Pad menus

Note Pad menus are shown here for your reference, and Note Pad features that are not explained elsewhere in this book are described here.

See “Using menus” in Chapter 1 for information about choosing menu commands.

The Record and Options menus differ depending on whether you’re displaying the Note Pad list or an individual note.

Record menus

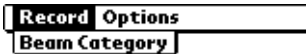

Note Pad list

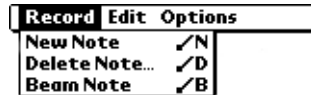

Note screen

Options menus



Note Pad list



Note screen



Preferences Displays the Note Pad Preferences dialog box, where you define the sort order for notes and the alarm sound.

About Note Pad Shows version information for Note Pad.

Memo Pad

A memo can contain up to 4,000 characters. The number of memos you can store is dependent only on the memory available on your handheld. A record in Memo Pad is called a “memo.”

To create a new memo:

1. Tap the Applications icon .
2. Tap the Memo Pad icon  to display the Memo list.
3. Tap New.

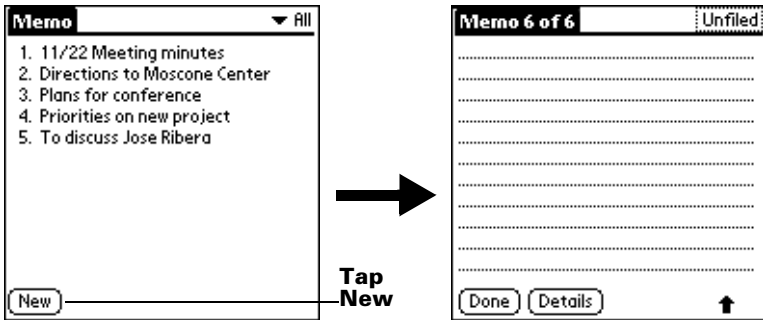

Tip: In the Memo list screen, you can also begin writing in the Graffiti writing area to create a new memo. The first letter is automatically capitalized and begins your new memo.

4. Enter the text you want to appear in the memo. Use the carriage return stroke to move down to new lines in the memo.
5. Tap Done.

Reviewing memos

The first line of a memo appears in the Memo list. This makes it easy to locate and review your memos.

To review a memo:

1. In the Memo list, tap the text of the memo.

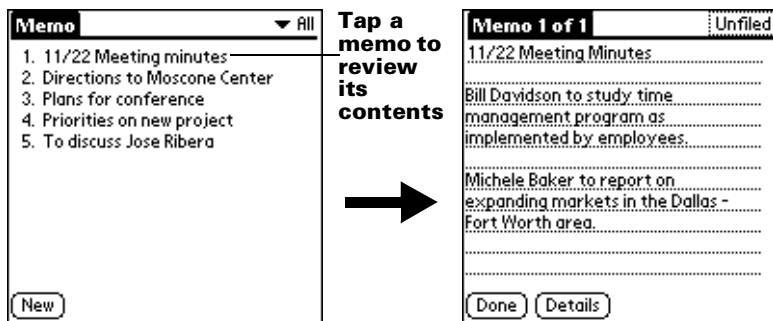

2. Review or edit the text in the memo.
3. Tap Done.

Memo Pad menus

Memo Pad menus are shown here for your reference, and Memo Pad features that are not explained elsewhere in this book are described here.

See “Using menus” in Chapter 1 for information about choosing menu commands.

The Record and Options menus differ depending on whether you’re displaying the Memo list or an individual memo.

Record menus

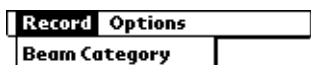

Memo list

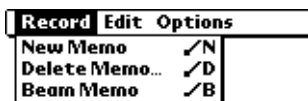

Memo screen

Options menus



Memo list



Memo screen

Preferences Displays the Memo Preferences dialog box, where you define the sort order for memos.

About Memo Pad Shows version information for Memo Pad.

Calculator

The Calculator includes several buttons to help you perform calculations.

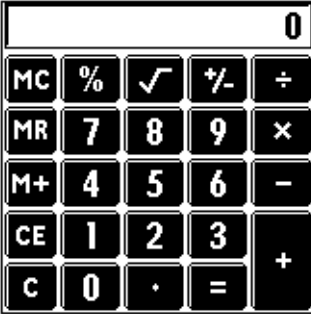

Clears the entire calculation and enables you to begin a fresh calculation.



Clears the last number you entered. Use this button if you make a mistake while entering a number in the middle of a calculation. This button enables you to re-enter the number without starting the calculation over.



Toggles the current number between a negative and positive value. If you want to enter a negative number, enter the number first *and then press* the +/- button.



Places the current number in memory. Each new number you enter with the M+ button is *added to the total* already stored in memory. The number that you add can be either a calculated value or any number you enter by pressing the number buttons. Pressing this button has no effect on the current calculation (or series of calculations); it merely places the value into memory until it is recalled.



Recalls the stored value from memory and inserts it in the current calculation.



Clears any value that is stored in the Calculator memory.



Calculates the square root of a number. Enter the number, then tap the square root button.

Recent Calculations

The Recent Calculations command enables you to review the last series of calculations and is particularly useful for confirming a series of “chain” calculations.

To display recent calculations:

1. Tap the Menu icon .
2. Tap Options, and then tap Recent Calculations.

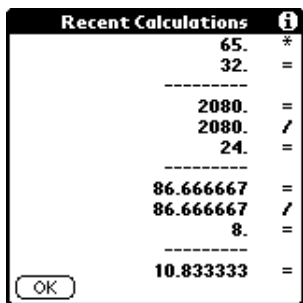

3. After you finish reviewing the calculations, tap OK.

Calculator menus

Calculator menus are shown here for your reference, and Calculator features that are not explained elsewhere in this book are described here.

See “Using menus” in Chapter 1 for information about choosing menu commands.

Options menus

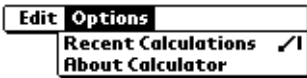

About Calculator Shows version information for Calculator.

Clock

Clock makes it easy for you to check the time and date, and provides a convenient travel alarm feature. See “Customizing your handheld” in Chapter 1 for details on setting the current date and time for all the applications on your handheld.

In addition to setting the date and time, you can set an alarm to sound during the next 24-hour period.

To view the time:

Do one of the following:

- When your handheld is on, tap the Clock icon ☺ in the upper-left corner of the Graffiti writing area, or tap the Applications icon ☰, and then tap the Clock icon ☺.
- When your handheld is off, press the up scroll button. To activate the backlight while viewing the time, hold down the up scroll button for a few seconds.

To set an alarm:

1. Tap the Applications icon ☰.
2. Tap the Clock icon ☺.
3. Tap the Alarm box to open the Set Alarm dialog box.

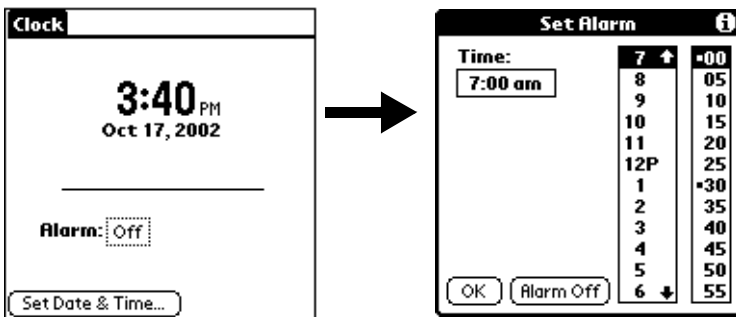

4. Tap the time columns to set the hour and minute.
5. When the alarm reminder message appears, do one of the following:

Tap OK to permanently dismiss the reminder and return to the current screen.

Tap Snooze to dismiss the reminder and return to the current screen. The reminder message appears again in five minutes, and an attention indicator blinks in the upper-left corner of the screen to remind you of the pending alarm. When the reminder message reappears, the current time displays in the Reminder bar and the alarm time displays on the screen.

6. Tap Go To to open Clock.



Clock menus

Clock menus are shown here for your reference, and Clock features that are not explained elsewhere in this book are described here.

See “Using menus” in Chapter 1 for information about choosing menu commands.

Options menu

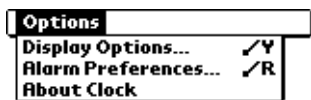

**Display
Options**

Allows you to choose which information appears on the Clock screen.

- **Day.** Activates the day of the week display. When it is on, the day appears above the time.
- **Date.** Activates the date display. When it is on, the date appears below the time.

**Alarm
Preferences**

- **Sound.** Sets the sound of the alarm. The choices are Alarm, Bumble Bee, Reveille, Sonata, Wake Up, and Warbler.
- **Volume.** Defines how loud the alarm sounds. The choices are Low, Medium, and High.

About Clock

Shows version information for Clock.

Chapter 6

Advanced HotSync® Operations

HotSync® technology enables you to synchronize data between one or more Palm OS® handhelds and Palm™ Desktop software or another PIM such as Microsoft Outlook. To synchronize data, you must connect your handheld and Palm Desktop software. You can synchronize your data either directly or indirectly. Direct methods include connecting your handheld to the cradle/cable attached to your computer, or using infrared communications. An indirect method is using a modem.

This chapter describes how to select HotSync options and perform a HotSync operation via infrared communications or a modem. See “Exchanging and updating data: HotSync operations” in Chapter 5 for information about performing your first and subsequent local HotSync operations.

Selecting HotSync setup options

You can choose when you want HotSync Manager to run. If necessary, you can adjust the local and modem HotSync settings as well.

To set the HotSync options on a Windows computer:

1. Click the HotSync Manager icon in the Windows system tray.
2. Choose Setup.

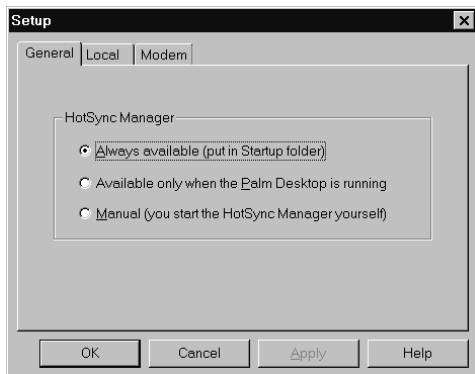

3. Click the General tab and select one of the following options:

Always available Adds HotSync Manager to the Startup folder and constantly monitors the communication port for synchronization requests from your handheld. With this option, the HotSync Manager synchronizes data even when Palm Desktop software is not running.

Available only when Palm Desktop software is running Starts HotSync Manager and monitors requests automatically when you open Palm Desktop software.

Manual Monitors requests only when you select HotSync Manager from the Start menu.

Tip: If you're not sure which option to use, keep the default setting: Always available.

4. If you are using an optional serial cradle/cable, click the Local tab to display the settings for the connection between your computer and the handheld cradle/cable, and adjust the following options as needed.

Note: If you are using the USB cradle/cable, you do not need to use the settings on the Local tab for a direct HotSync operation.

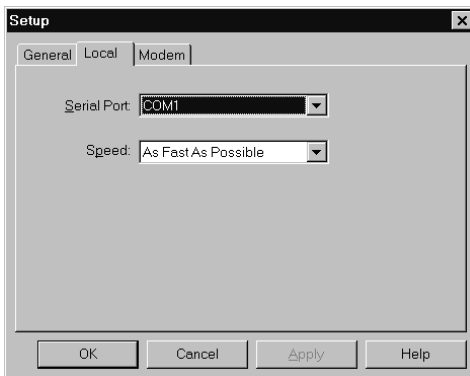

Serial Port Identifies the port that HotSync Manager uses to communicate with the cradle/cable. The Palm Desktop installation software automatically detects the port to which you connected the cradle/cable. If necessary, you can change the port selection.

Note: Your handheld cannot share this port with an internal modem or other device.

Speed Determines the speed at which data is transferred between your handheld and Palm Desktop software. Try the As Fast As Possible rate first, and adjust downward if you experience problems. This setting allows Palm Desktop software and your handheld to find and use the fastest speed.

5. Click the Modem tab to display the modem settings and adjust the options as needed. See “Conducting a HotSync operation via modem” later in this chapter for more information.
6. Click OK.

To set the HotSync options on a Macintosh:

1. Double-click the HotSync Manager icon in the Palm folder.
2. Click the HotSync Controls tab and select any of the following options.

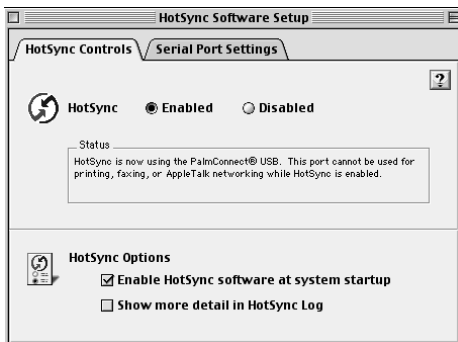

HotSync Enabled/ Disabled

Activates the serial port monitor and prepares your Macintosh to synchronize with your handheld. By default, the serial port monitor is enabled whenever you start your Macintosh. Keep this default if your cradle/cable is always connected to a specific port (USB, serial, or modem). If, however, you use the same port for other devices besides the cradle/cable, disable the serial port monitor and then enable it manually only when you connect the cradle/cable to perform a HotSync operation.

Enable HotSync software at system startup

Activates the serial port monitor automatically each time you start your computer. If this option is not checked, you must open HotSync Manager and select the Enabled option before you can perform a HotSync operation.

Show more detail in HotSync Log

Includes more troubleshooting information in the log that is generated when you perform a HotSync operation.

- 3. If you are using the optional serial cradle/cable, click the Serial Port Settings tab and select any of the following options.

Note: If you are using the USB cradle/cable, you do not need to adjust the settings on the Serial Port Settings tab for a direct HotSync operation; they are automatically set when you perform the first HotSync operation.

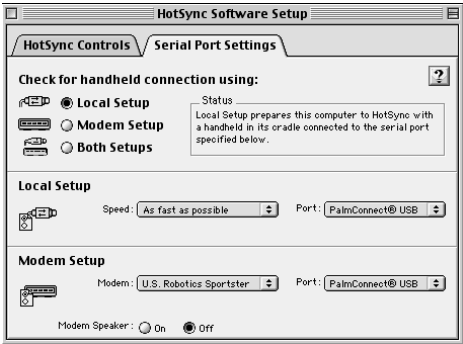

Check for a handheld connection using

Select the method you use to synchronize your handheld and your desktop applications:

Local Setup. Synchronizes while your handheld and cradle/cable are connected to this Macintosh.

Modem Setup. Synchronizes while your handheld communicates to this Macintosh across a telephone line.

Both Setups. Synchronizes using the cradle/cable, or through the modem; HotSync Manager monitors both connections for communication from a handheld.

Note: Choosing Both Setups prevents you from using either port for other operations such as printing, faxing, or AppleTalk networking.

Local Setup

Enables you to perform HotSync operations using the cradle/cable that is connected to your Macintosh. If you are using the USB cradle/cable for a direct HotSync operation, you do not need to set these options; set them if you are using the optional serial cradle/cable.

- **Speed.** Determines the speed at which data is transferred between your handheld and Palm Desktop software. Try the As Fast As Possible rate first, and adjust downward if you experience problems. This setting allows Palm Desktop software and your handheld to find and use the fastest speed.
- **Port.** Identifies the port that Palm Desktop software uses to communicate with the cradle/cable. Select the port where you connected the cradle/cable. If you perform IR HotSync operations, select Infrared port.

Modem Setup

Enables you to perform HotSync operations across a telephone line. To do this you must purchase an optional add-on modem accessory for your handheld, have a modem connected to your Macintosh, and set the following options:

- **Modem.** Identifies the type of modem connected to your Macintosh. If your modem does not appear on the list, use the Hayes setting, or choose Custom to enter a command string. Refer to the manual that came with your modem to find the appropriate command string.
- **Port.** Identifies the port that Palm Desktop software uses to communicate with the modem. Select the USB, modem, or printer port where you connected the modem cable.
- **Modem Speaker.** Activates the modem's speaker. If you are having trouble connecting, turn on this option to make sure the modem connected to your Macintosh is responding to incoming calls.

Note: You can set both Local and Modem settings and prepare your Macintosh to synchronize using the cradle/cable or a modem. However, choosing both setups prevents you from using either port for other operations such as printing, faxing, or AppleTalk networking.

4. Close the HotSync Software Setup window.

Customizing HotSync application settings

For each application, you can define a set of options that determines how records are handled during synchronization. These options are called a “conduit.” By default, a HotSync operation synchronizes all files between the handheld and Palm Desktop software.

In general, you should leave the settings to synchronize all files. The only reason you might want to change these settings is to overwrite data on either your handheld or Palm Desktop software, or to avoid synchronizing a particular type of file because you don’t use it.

In addition to the conduits for Date Book, Address Book, To Do List, Note Pad, and Memo Pad, Palm Desktop software includes System and Install conduits. The System conduit backs up the system information stored on your handheld, including Graffiti® ShortCuts. The Install conduit installs add-on applications on your handheld.

To customize HotSync application settings on a Windows computer:

1. Click the HotSync icon ™ in the Windows system tray (bottom-right corner of the taskbar).

Tip: You can also click the HotSync command on the Palm Desktop software menu bar.

2. From the HotSync Manager menu, choose Custom.

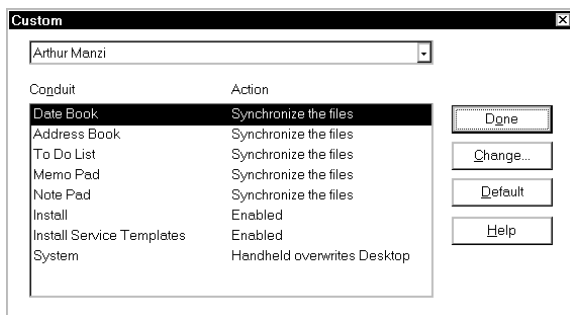

3. Select the appropriate user name from the list.
4. Select an application in the Conduit list.
5. Click Change.

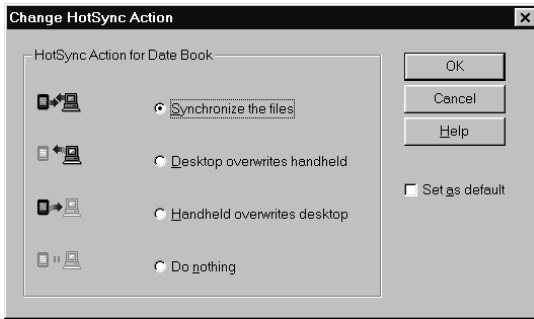

6. Click the direction in which you want to write data, or click Do Nothing to skip data transfer for an application.

Note: Changing the HotSync setting from the default affects only the *next* HotSync operation. Thereafter, the HotSync Actions revert to their default settings. To use a new setting on an ongoing basis, select the Set As Default box. Thereafter, whatever you selected as the default setting is used when you click the Default button in the Custom dialog.

7. Click OK.
8. Repeat steps 4 through 7 to change conduit settings for other applications.
9. Click Done to activate your settings.

To customize HotSync application settings on a Macintosh:

1. Double-click the Palm Desktop icon in the Palm folder.
2. From the HotSync menu, choose Conduit Settings.

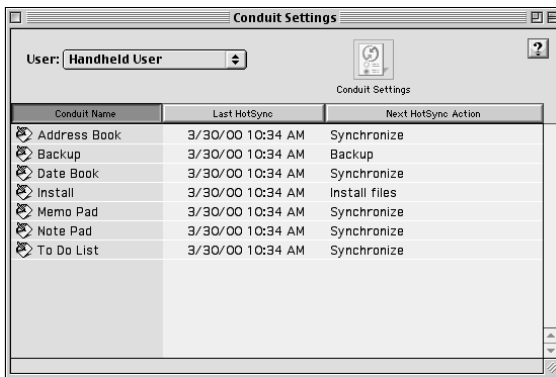

3. From the User pop-up menu, select the appropriate user name.
4. Select an application in the Conduit list.
5. Click Conduit Settings.

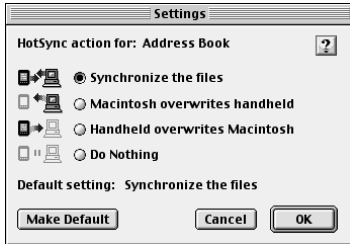

6. Click the direction in which you want to write data, or click Do Nothing to skip data transfer for an application.

Note: Changing the HotSync setting from the default affects only the *next* HotSync operation. Thereafter, the HotSync Actions revert to their default settings. To use a new setting on an ongoing basis, click Make Default. Thereafter, whatever you selected as the default setting is used for HotSync operations.

7. Click OK.
8. Repeat steps 4 through 7 to change conduit settings for other applications.
9. Close the Conduit Settings window.

IR HotSync operations

Your handheld is equipped with an infrared (IR) port that supports the IrCOMM implementation of the standards for infrared communication established by the Infrared Data Association (IrDA). This means that not only can you beam data to another Palm OS handheld that's equipped with an IR port, but you can also beam data to a mobile phone and any other device that supports the IrCOMM implementation of the IrDA standards.

Most importantly, you can use the IR port to perform HotSync operations; you don't need your cradle/cable. This is especially useful if you travel with an infrared-enabled laptop. You simply enable infrared communication on your laptop and handheld and follow the steps in "Performing an IR HotSync operation" later in this section.

Preparing your computer for infrared communication

Before you can perform a HotSync operation using the IR port, the computer with which you want to synchronize must fulfill these requirements:

- Your computer must support the IrCOMM implementation of the IrDA standards.
- Your computer must have an enabled infrared port that's built into the computer, or an enabled infrared device attached to the computer.

Some desktop computers may require an infrared device attached to a physical COM port. Laptops are likely to have a built-in IR port, so no external device is necessary.

- Your computer must have an installed infrared driver.
If you have an external infrared device attached to your computer, a driver is probably included with the device. Consult the documentation included with the device for information on installing the required driver.

Check your computer's documentation to learn if the computer supports infrared communication.

Configuring HotSync Manager for infrared communication

Next, you need to configure HotSync Manager for infrared communication.

To configure HotSync Manager for infrared communication on a Windows computer:

1. Click the HotSync Manager icon  in the Windows system tray, and make sure Infrared is checked. If you do not have an Infrared option on the HotSync Manager menu, complete the following steps.
2. Make sure Local Serial is checked on the menu.
3. Choose Setup.
4. Click the Local tab.

5. In the Serial Port drop-down box, select the simulated port that your computer uses for infrared communication.

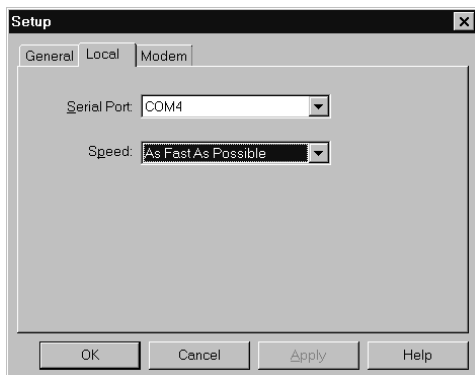

Note: See the documentation for your operating system for instructions on finding the simulated port. This information is usually located in the Control Panel.

6. Click OK.

Note: If your cradle/cable is connected to a USB port, you can continue using it while HotSync Manager is configured for infrared communication. If your cradle/cable is connected to a serial port, you cannot use your cradle/cable again until you reconfigure the HotSync Manager to communicate with the port defined for cradle/cable synchronization.

To configure HotSync Manager for infrared communication on a Macintosh:

1. Double-click the HotSync Manager icon in the Palm folder.
2. In the HotSync Controls tab, select Enabled.
3. Click the Serial Port Settings tab.
4. Under Check for handheld connection using, select Local Setup.

- Under Local Setup, select Infrared Port from the Port pop-up menu.

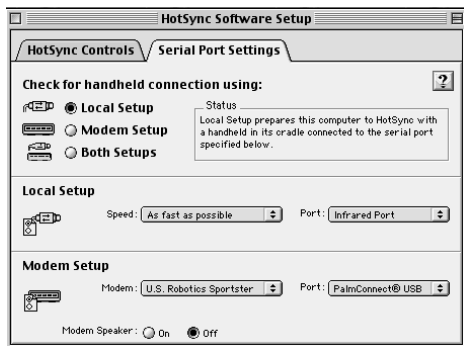

- Close the HotSync Software Setup window.

Performing an IR HotSync operation

After you complete the steps to prepare for performing an IR HotSync operation, it is easy to perform the actual operation.

To perform an IR HotSync operation:

- In the Applications Launcher, tap the HotSync icon.
- Tap Local.
- Tap the pick list below the HotSync icon and select IR to a PC/Handheld.
- Position the IR port of your handheld within a couple of inches of the infrared port of your computer.
- Tap the HotSync icon to start the IR HotSync operation.

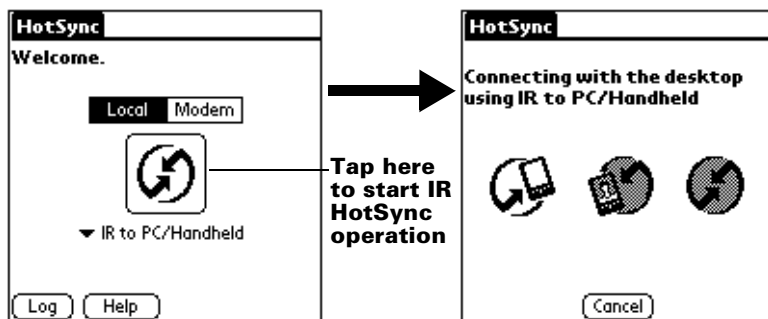

Returning to cradle/cable HotSync operations

It's easy to return to using the cradle/cable for HotSync operations.

Note: If your cradle/cable is connected to a USB port, you can continue using it while HotSync Manager is configured for infrared communication. Use the following instructions to return to local USB cradle/cable HotSync operations only when needed, such as when you have disconnected the cradle/cable from the USB port.

To return to local USB cradle/cable HotSync operations on a Windows computer:

1. If needed, connect the cradle/cable to the USB port of your computer you use for HotSync operations.
2. Click the HotSync Manager icon  in the Windows system tray, and select Local USB if it is not already checked.

To return to local serial cradle/cable HotSync operations on a Windows computer:

1. If needed, connect the cradle/cable to the port of your computer you use for HotSync operations.
2. Click the HotSync Manager icon  in the Windows system tray.
3. Choose Setup, and then click Local.
4. Select the COM port where your cradle/cable is connected.
5. Click OK.

To return to local serial cradle/cable HotSync operations on a Macintosh:

1. If needed, connect the cradle/cable to a serial port on your Macintosh.
2. Double-click the HotSync Manager icon in the Palm folder.
3. In the HotSync Controls tab, select Enabled.
4. Click the Serial Port Settings tab.
5. Under Check for handheld connection using, select Local Setup.
6. Under Local Setup, select the port where your cradle/cable is connected from the Port pop-up menu.
7. Close the HotSync Software Setup window.

Now, the next time you want to perform a HotSync operation, just press the HotSync button on the cradle/cable.

Conducting a HotSync operation via modem

You can use a modem to synchronize your handheld when you are away from your computer.

Note: The first HotSync operation must be local, using the cradle/cable. After that, you can perform a modem HotSync operation.

To perform a HotSync operation via modem you need the following:

- A modem connected to your computer.
- Palm Desktop software configured for use with the modem.
- A modem connected to your handheld.
- A configuration for the kind of modem connection you want to make. See “Connection preferences” in Chapter 7 for more information.

Preparing your computer

There are a few steps you must perform to prepare your computer for a modem HotSync operation. Be sure to perform these steps before you leave your office so that your computer is ready to receive a call from your handheld.

To prepare your Windows computer for a modem HotSync operation:

1. Confirm that the computer modem is connected and turned on, and that no communications applications, such as fax or telephony software, are running on a COM port.

Note: Make sure the computer is disconnected from all online services, such as America Online (AOL). This helps to avoid conflicts with the COM port.

2. Start HotSync Manager if it is not already running, and from the HotSync Manager menu, choose Modem.

3. Adjust the following options as needed.

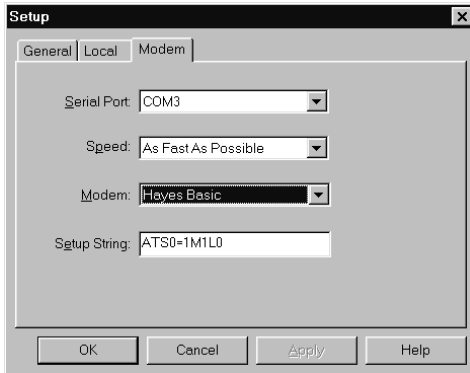

Serial Port

Identifies the port for the modem. If you are unsure of the port assignment, look at the Modem Properties in the Windows Control Panel.

Speed

Determines the speed at which data is transferred. Try the As Fast As Possible rate first, and adjust downward if you experience problems. This setting allows Palm Desktop software and your handheld to find and use the fastest speed.

Modem

Identifies the modem type or manufacturer. Refer to your modem manual or face plate for its type or settings. If you're not sure of your modem type or your modem doesn't match any that appear in the list, select Hayes Basic.

Setup String

Identifies the setup string for your particular modem. Not all modems require a setup string. Refer to your modem manual and enter the setup string if recommended by the manufacturer.

4. Click OK.

To prepare a Macintosh for a modem HotSync operation:

1. Confirm that the Macintosh modem is connected and turned on, and that no communications applications, such as fax or telephony software, or AppleTalk networking are running on that serial port.

Note: Make sure the Macintosh is disconnected from all online services, such as CompuServe and America Online (AOL). This helps to avoid conflicts with the serial port.

2. Double-click the HotSync Manager icon in the Palm folder.
3. Click the Serial Port Settings tab.
4. Under Check for handheld connection using, click Modem Setup.
5. Adjust the following options as needed.

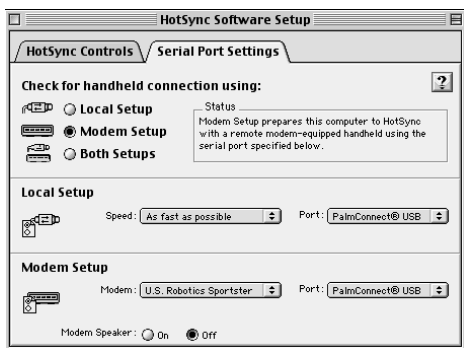

Modem

Identifies the type of modem connected to your Macintosh. If your modem does not appear on the list, use the Hayes Basic setting, or choose Custom to enter a command string. Refer to the manual that came with your modem to find the appropriate command string.

Port

Identifies the port that Palm Desktop software uses to communicate with the modem. Select the modem or printer port where you connected the modem cable.

Modem Speaker



Activates the modem's speaker. If you are having trouble connecting, turn on this option to make sure the modem connected to your Macintosh is responding to incoming calls.

6. Close the HotSync Software Setup window.

Preparing your handheld

There are a few steps you must perform to prepare your handheld for a modem HotSync operation.

To prepare your handheld for a modem HotSync operation:

1. Tap the Applications icon .
2. Tap the HotSync icon .
3. Tap Modem.
4. Tap the pick list below the icon and select a modem configuration.

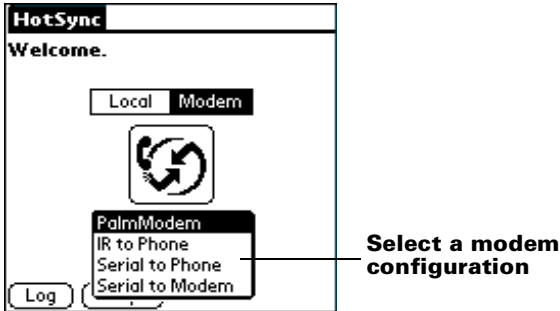

Note: If you need to create a configuration, tap the Menu icon and then select Options and Connection Setup. See “Connection preferences” in Chapter 7 for more information.

5. Tap the Enter phone # field.

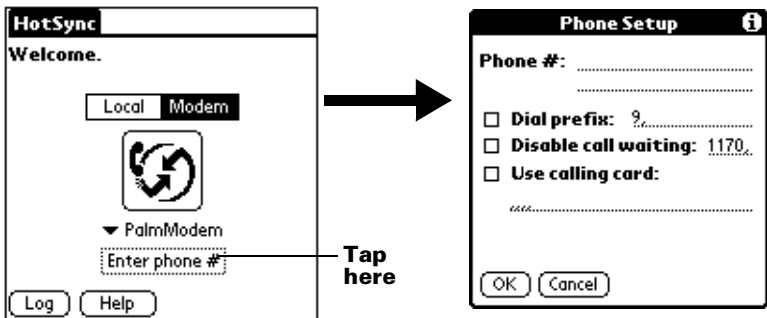

6. Enter the telephone number to access the modem connected to your computer.
7. If needed, enter a dial prefix (such as “9”) to access an outside line, and then tap the Dial Prefix check box.



Tip: You can enter a comma in the field to introduce a “pause” in the dialing sequence. Each comma equals a two second pause.

8. If the phone line you’re using for the handheld has Call Waiting, select the Disable call waiting check box to avoid an interruption during the modem HotSync operation.
9. If you want to use a calling card to place the call, select the check box and enter the calling card number.
10. Tap OK.

Selecting the conduits for a modem HotSync operation

The Conduit Setup dialog box on your handheld enables you to define which files and/or applications synchronize during a modem HotSync operation. You can use these settings to minimize the time required to synchronize data with a modem.

To change the Conduit Setup for a modem HotSync operation:

1. Tap the Applications icon .
2. Tap the HotSync icon .
3. Tap the Menu icon .
4. Tap Options, and then tap Conduit Setup.
5. Tap the check boxes to deselect the files and applications that you do *not* want to synchronize during a modem HotSync operation. The default setting is to synchronize all files.





Note: Applications that do not have a database (such as games) do not synchronize — even if you select the item in the Conduit Setup dialog box.

6. Tap OK.

Performing a HotSync operation via a modem

After you prepare your computer and your handheld, and select your Conduit Setup options, you are ready to perform a modem HotSync operation.

To perform a modem HotSync operation:

1. Tap the Applications icon .
2. Tap the HotSync icon .
3. Tap the Modem icon  to dial the Palm Desktop modem and synchronize the applications.
4. Wait for the HotSync operation to complete. If you have any problems conducting a successful HotSync operation, see Appendix B.

Using File Link

The File Link feature enables you to import Address Book and Memo Pad information onto your handheld from a separate external file such as a company phone list. HotSync Manager stores the data in a separate category on your Palm Desktop software and your handheld. You can configure the File Link feature to check for changes to the external file when you perform a HotSync operation.

With File Link, you can import data stored in any of the following formats:

- Comma-separated (*.csv)
- Memo Pad archive (*.mpa)
- Address Book archive (*.aba)
- Text (*.txt)

For information on how to set up a file link, see the Palm Desktop online Help.

Note: The File Link feature is not available in Palm Desktop software for the Macintosh.

Creating a user profile

A user profile enables you to install the same set of data onto multiple Palm OS handhelds before each handheld is individualized with a specific user name and data file.

A handheld that is preconfigured with a user profile can be given to anyone because the handheld is not yet identified by a unique user

name. The handheld acquires a unique user name when the new user performs his or her first local HotSync operation.

For example, suppose a sales organization wants to distribute two dozen handhelds that all have a common company phone list, a set of memos, and several key applications. A user profile can be created to install the common data before the handhelds are distributed to the employees who will use them. Then when the employees perform their first HotSync operation, the common data becomes part of their individual data file.

Note: The handhelds that are synchronized with a user profile must either be new ones that have never been synchronized or handhelds that have had their user name and data removed by a hard reset.

To create a user profile on a Windows computer:

1. Open Palm Desktop software.
2. From the Tools menu, choose Users.
3. Click Profiles.
4. Click New.

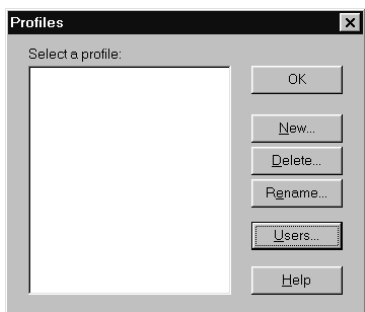

5. Enter a unique name for the profile and click OK.



6. Repeat steps 3 and 4 for each profile that you want to create, and then click OK to return to Palm Desktop software.

7. Select the profile from the User list and create the data for the profile (e.g., company phone list, etc.).

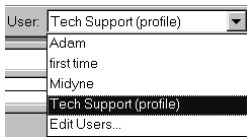

To create a user profile on a Macintosh:

1. Open Palm Desktop software.
2. From the User pop-up menu, choose Edit Users.
3. Click New Profile.

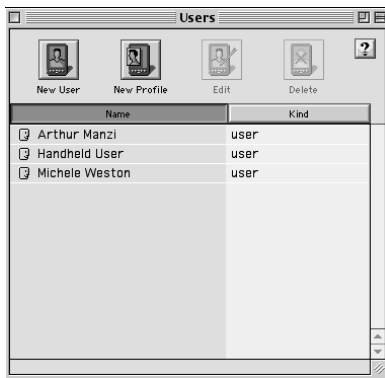

4. Enter a unique name for the profile and click OK.



5. Close the Users window.
6. From the User pop-up menu, choose the new profile.
7. Create the data for the profile (such as a company phone list).
8. From the HotSync menu, choose Conduit Settings.
9. Select the conduit settings for the profile. See "Customizing HotSync application settings" earlier in this chapter for details.

Performing the first HotSync operation with a user profile

To use a profile for the first-time HotSync operation on a Windows computer:

1. Connect the new handheld to the cradle/cable.
2. Press the HotSync button  on the cradle/cable.
3. Click Profiles.
4. Select the profile you want to load on the handheld, and click OK.

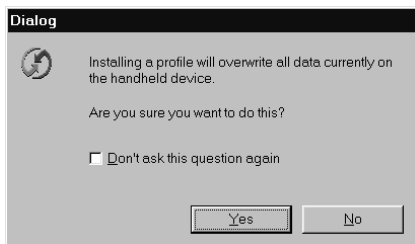

5. Click Yes to transfer all the profile data to the handheld.

The next time you perform a HotSync operation, Palm Desktop software prompts you to assign a user name to the handheld.

To use a profile for the first-time HotSync operation on a Macintosh:

1. Connect the new handheld to the cradle/cable.
2. Press the HotSync button  on the cradle/cable.
3. Select the profile you want to load on the handheld, and click OK to transfer all the profile data to the handheld.

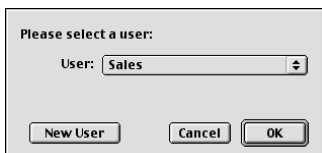

The next time you perform a HotSync operation with this handheld, Palm Desktop software prompts you to assign a user name to the handheld.

Chapter 7



Setting Preferences for Your Handheld

The Preferences screens enable you to customize the configuration options on your handheld, including the following:

General	Set the auto shut-off interval, the system, alarm, and game sounds, and the Beam Receive feature.
Date and Time	Set the date, time, time zone, and Daylight Saving switch.
Formats	Set the country default and the formats for dates, times, calendar, and numbers.
Connection	Configure cradle/cable, modem, and infrared communication settings.
Owner	Assign your name, phone number, and other owner information to your handheld.
Buttons	Assign different applications to the buttons on the front panel of your handheld and the HotSync® button on the cradle/cable, and reassign the full-screen pen stroke command.
ShortCuts	Define a list of Graffiti® abbreviations.
Digitizer	Calibrate the screen on your handheld.

Viewing preferences

To open the Preferences screens:

1. Tap the Applications icon .
2. Tap the Preferences icon .
3. Tap the pick list in the upper-right corner of the screen.
4. Select the Preferences screen you want to view.

Buttons preferences

The Buttons Preferences screen enables you to associate different applications with the buttons on the front of the handheld.

For example, if you find that you seldom use To Do List and often use Memo Pad, you can assign the To Do List button to start Memo Pad.

Any changes you make in the Buttons Preferences screen become effective immediately; you do not have to change to a different screen or application.

If you assign a different application to a button, you can still access the original application using the Applications Launcher.

To change the Buttons preferences:

1. Tap the pick list next to the button you want to re-assign.

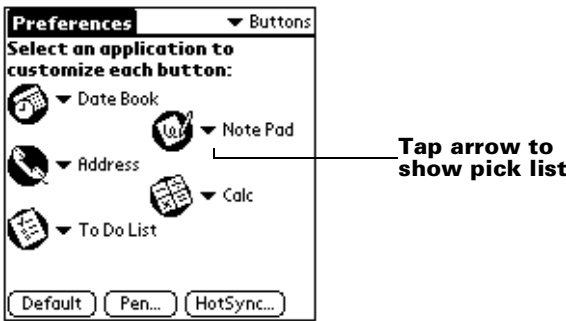

2. Tap the application that you want to assign to the button.

Tip: To restore all of the buttons to their factory settings, tap Default.

Pen preferences

The Buttons Preferences screen enables you to change the assignment of the full-screen pen stroke. By default, the full-screen pen stroke activates Graffiti Help.

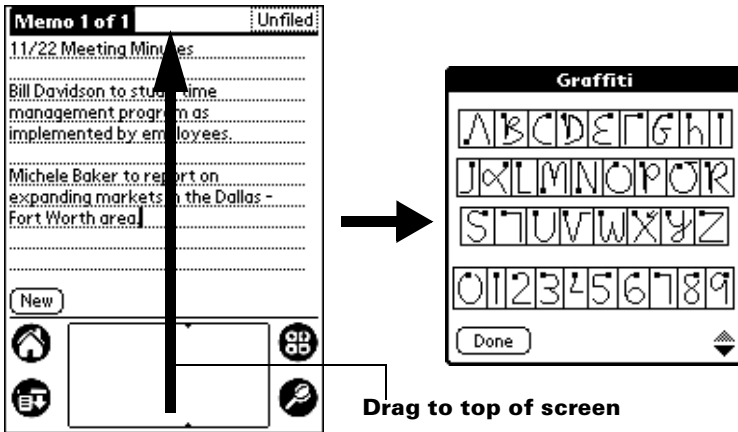

To change the Pen preferences:

1. Tap Pen.

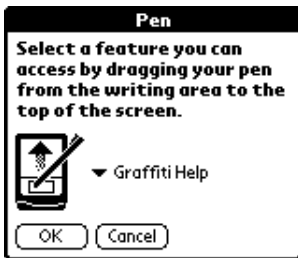

2. Tap the pick list and select one of the following settings for the full-screen pen stroke:

Backlight Turns on the backlight of your handheld.

Keyboard Opens the onscreen keyboard for entering text characters.

Graffiti Help Opens a series of screens that show the complete Graffiti character set.

Turn Off & Lock

Turns off and locks the handheld. You must assign a password to lock the handheld. When locked, you need to enter the password to use your handheld.

Beam Data

Beams the current record to another Palm OS® handheld.

3. Tap OK.

HotSync buttons preferences

The Buttons Preferences screen also enables you to associate different applications with the HotSync button on the cradle/cable and the HotSync button on the optional PalmModem® accessory. Any changes that you make in the HotSync Buttons dialog box become effective immediately; you do not have to change to a different screen or application.

To change the HotSync buttons preferences:

1. Tap HotSync.
2. Tap the pick list next to the button you want to assign.

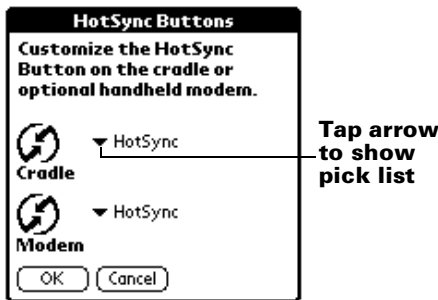

3. Tap the application that you want to assign to each button.
The default setting for each button is the HotSync setting, which means the cradle/cable and optional PalmModem accessories perform their normal HotSync functions.
4. Tap OK.

Digitizer preferences

The Digitizer Preferences screen opens the digitizer calibration screen. This is the same screen that appears when you start your handheld for the first time.

You can recalibrate your screen after a hard reset, or if your digitizer drifts.

Formats preferences

Use the Formats Preferences screen to set the country default and the display format of the dates, times, and numbers on your handheld.

Country default

The country default sets date, time, week start day, and number conventions based on geographic regions where you might use your handheld. For example, in the United Kingdom, time often is expressed using a 24-hour clock. In the United States, on the other hand, time is expressed using a 12-hour clock with an am or pm suffix.

All your handheld applications use the Country default settings. You can, however, customize your own preferences as described in “Time, date, week start, and numbers formats” later in this chapter.

To set the country default:

1. Tap the country name pick list.

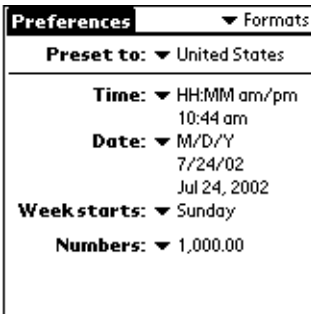

2. Tap the setting you want to use.

Time, date, week start, and numbers formats

The Time setting defines the format for the time of day. The time format that you select appears in all applications on your handheld.

To select the time, date, week start, and numbers format:

1. Tap the Time pick list and select a format.
2. Tap the Date pick list and select a format.
3. Tap the Week starts pick list, and select whether you want the first day of the week to be Sunday or Monday.

Note: This setting controls the Day, Week, and Month views in Date Book and all other aspects of your handheld that display a calendar.

4. Tap the Numbers pick list, and select formats for the decimal point and thousands separator.

General preferences

The General Preferences screen enables you to set the auto shutoff interval, alarm options, sounds for your handheld, and the Beam Receive feature.

Auto-off delay

Your handheld has an automatic shutoff feature that turns off the power and backlight after a period of inactivity. This feature helps conserve battery power in case you forget to turn off your handheld.

If you find that your handheld shuts itself off before you finish reviewing the information on the screen, you should increase the time setting of the automatic shutoff feature.

To set the Auto-off delay:

1. Tap the Auto-off pick list.
2. Tap the setting you want to use for the automatic shutoff feature: 30 seconds, 1 minute, 2 minutes, or 3 minutes.

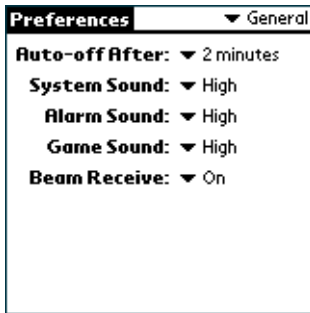

System, alarm, and game sounds

Your handheld uses a variety of sounds. The System, Alarm, and Game Sound settings enable you to turn the sounds on or off, and to adjust the volume level.

To set the system and alarm sounds:

1. Tap the System Sound pick list and select the sound level.

Note: When you turn off the System Sounds, you also turn off the “chime” tones associated with the HotSync operation.

2. Tap the Alarm Sound pick list and select the sound level.
3. Tap the Game Sound pick list and select the sound level.

Note: The Game Sound setting works only with games that are programmed to respond to this setting. Older games typically do not respond to this setting.

Beam Receive

You can choose to turn off the Beam Receive feature. This prohibits anyone from beaming information to your handheld. It also results in a slight saving of battery power.

To change the Beam Receive setting:

- Tap the Beam Receive pick list and select On or Off.

Date and Time preferences

The Date and Time Preferences screen enables you to set the date, time, time zone, and Daylight Saving option on your handheld.

See “Customizing your handheld” in Chapter 1 for information about using this screen.

Connection preferences

The Connection Preferences screen enables you to define the settings used to connect your handheld to other devices. The screen displays a list of available configurations that are ready to be further defined; the list varies depending on the kind of software you’ve added to your handheld.

For example, a modem connection appears on the list. If you have this modem, you only need to specify the phone setup (and network connection, if required) to complete the configuration.

Note: You can purchase a PalmModem accessory for use with your handheld. See <http://www.palm.com>.

You can also create custom configurations, which include the following:

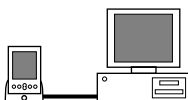

PC via Cradle/Cable: A local HotSync connection: the direct connection between your handheld and your desktop computer. Your handheld is connected by its universal connector to the cradle/cable, and the cradle/cable is attached to a USB port of your desktop computer. (If you are using the optional serial cradle/cable, it attaches to a serial (COM) port of your computer.)

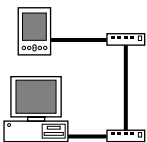

Modem via Cradle/Cable: A cable connection between your handheld’s universal connector and a modem for dialing in to a modem that is part of your computer or laptop.



PC via Infrared: A connection between the IR port of your handheld and the infrared device of your computer or laptop.

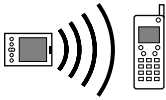

Modem via Infrared: A connection between the IR port of your handheld and a modem. The modem can be attached to or within a mobile phone or some other device containing an IR port. (Some IR phones contain modems.)

Editing connections

The following example shows you how to edit the IR to Phone connection to adjust the communication speed; you can similarly edit other connections or settings. You can use the IR to Phone connection to perform a remote IR HotSync operation. To accomplish the HotSync operation, your handheld sends data through its IR port to a modem attached to or within a mobile phone, which then dials a modem attached to or within your desktop computer, to synchronize with your Desktop application.

To edit the IR to Phone connection:

1. Select the IR to Phone connection and tap Edit.

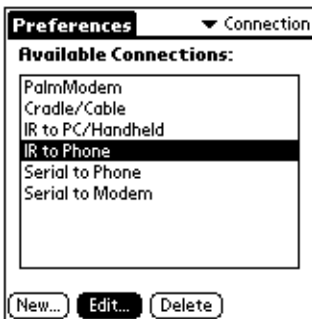

2. Tap Details.

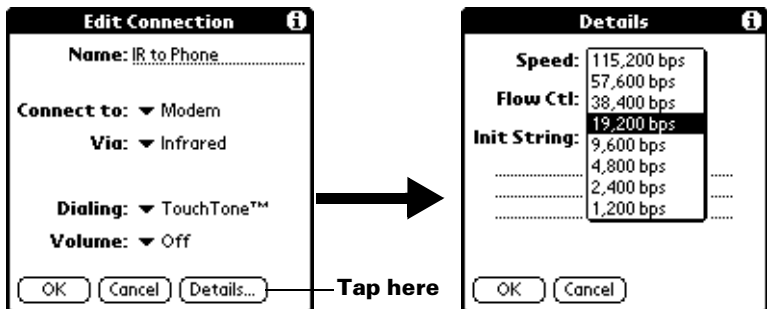

3. Tap the Speed pick list and select the appropriate speed.
4. Enter the initialization string supplied by the documentation for the modem attached to your mobile phone, if necessary.
5. Tap OK, and then tap OK again to save the configuration.

After you create the configuration, you need to set up the HotSync Manager of your Desktop application and the HotSync application of your handheld to perform a modem HotSync operation.

Network preferences and TCP/IP software

The Network Preferences settings enable you to use the TCP/IP software that is included in the handheld operating system. You can use the TCP/IP software to connect with Internet Service Providers (ISPs) or dial-in (remote access) servers. Because the TCP/IP software is a feature of the operating system, you configure all parameters relating to it from the Preferences application.

To use TCP/IP, you must create a configuration in Connection Preferences and then create Network Preferences settings.

Note: The Connection Preferences screen enables you to define several ways that your handheld can use a modem to communicate with remote devices. For example, you can communicate with your ISP server, or with your computer if you are away on travel. See “Connection preferences” earlier in this chapter for a complete explanation on how to create modem configurations.

After you configure both the Connection and Network Preferences, you can establish a PPP (Point-to-Point Protocol), SLIP (Serial Line Internet Protocol), or CSLIP (Compressed Serial Line Internet Protocol) connection with your ISP or dial-in server. You can do this either by using menu commands from the Network Preferences screen or by using a third-party application.

Note: TCP/IP provides the ability to connect to your ISP or dial-in server with applications that allow you to view the transmitted data. Visit the web site <http://www.palm.com> for information on third-party applications that take advantage of TCP/IP.

Selecting a service

Use the Service setting to select the service template for your ISP or dial-in server. Service templates are a set of ISP and dial-in server configuration settings that you can create, save, and reuse.

To select a service:

1. Tap the Service pick list.

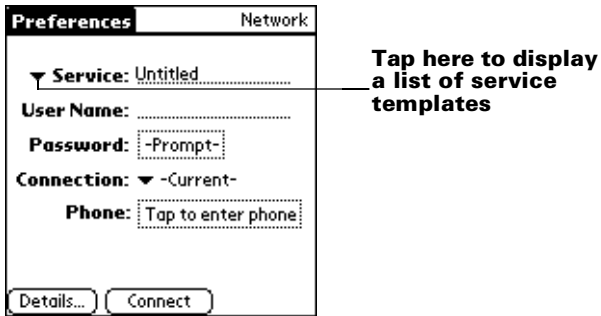

2. Tap the predefined service template you want to use.

Entering a user name

The User Name setting identifies the name you use when you log into your ISP or dial-in server. Although this field can contain multiple lines of text, only two lines appear onscreen.

To enter a user name:

1. Tap the User Name field.
2. Enter your user name.

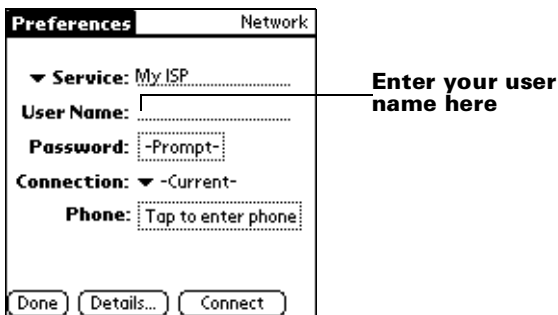

Note: Most dial-in servers do not accept spaces in the user name.

Entering a password

The Password box identifies the password you use to log into your ISP or dial-in server. Your entry in this field determines whether your handheld prompts you to enter a password each time you log into your network:

- If you do not enter a password, your handheld displays the word “Prompt” in this field and asks you to enter a password during the login procedure.
- If you enter a password, your handheld displays the word “Assigned” in this field and does not prompt you to enter a password during the login procedure.

Note: If you are concerned about security, select the Prompt option and do not enter a password.

To enter a password:

1. Tap the Password field.
2. Enter the password you use to log into your ISP or dial-in server.

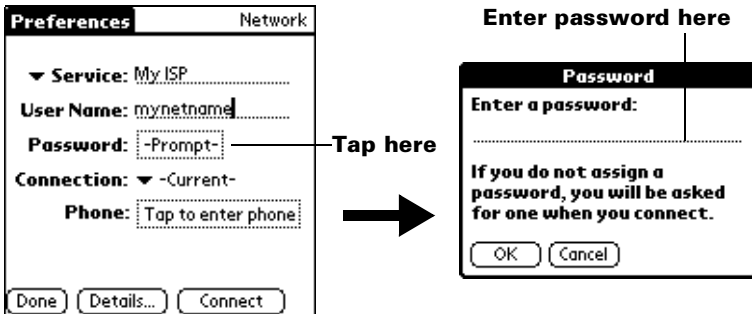

3. Tap OK.

Note: The Password field updates to display the word “Assigned.”

Selecting a connection

Use the Connection setting to select the method you want to use to connect to your ISP or dial-in server. See “Connection preferences” earlier in this chapter for information about creating and configuring connection settings.

To select a connection:

1. Tap the Connection pick list.

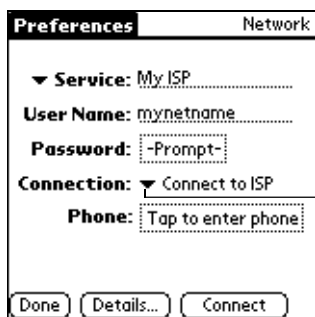

Tap here to display a list of available connections

2. Tap the connection you want to use.

Adding telephone settings

When you select the Phone field, your handheld opens a dialog box in which you define the telephone number you use to connect with your ISP or dial-in server. In addition, you can also define a prefix, disable Call Waiting, and give special instructions for using a calling card.

Note: The Phone Setup dialog box works correctly for AT&T and Sprint long-distance services. However, because MCI works differently, MCI customers need to put the calling card number in the Phone # field and the phone number in the Use calling card field.

To enter your server phone number:

1. Tap the Phone field.
2. Enter the phone number for your ISP or dial-in server.



Enter your ISP phone number here

3. If you need to enter a prefix or disable Call Waiting, skip to those procedures. Otherwise, tap OK.

Entering a prefix

A prefix is a number that you dial before the telephone number to access an outside line. For example, many offices require that you dial “9” to dial a number outside the building.

To enter a prefix:

1. Tap the Dial Prefix check box to select it.



2. Enter the prefix.
3. Tap OK.

Disabling Call Waiting

Call Waiting can cause your session to terminate if you receive a call while you are connected. If your telephone has Call Waiting, you need to disable this feature before logging into your ISP or dial-in server.

To disable Call Waiting:

1. Tap the Disable call waiting check box to select it.

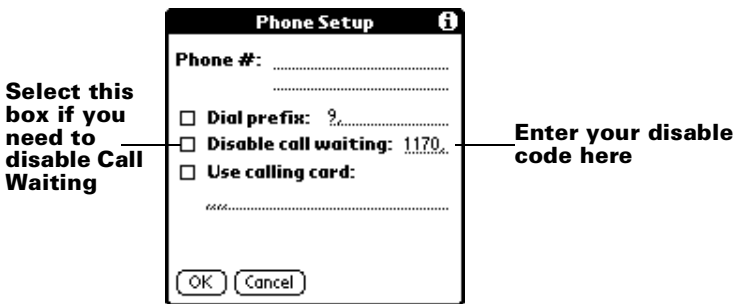

2. Enter the code to disable Call Waiting on the Disable call waiting line.

Note: Each telephone company assigns a code to disable Call Waiting. Contact your local telephone company for the code that is appropriate for you.

3. Tap OK.

Using a calling card

The Use calling card field enables you to use your calling card when dialing your ISP or dial-in server. Keep in mind that there is usually a delay before you enter your calling card number. When you define your calling card number, you need to add commas at the beginning to compensate for this delay. Each comma delays transmission of your calling card number for two seconds.

To use a calling card:

1. Tap the Use calling card check box to select it.



2. Enter your calling card number on the Use calling card line.

Note: It's a good idea to add at least three commas before your calling card number to compensate for the cue delay.

3. Tap OK.

Connecting to your service

After you set your Connection and Network Preferences, establishing a connection to your ISP or dial-in server is easy.

Note: If you are connecting to an ISP, you need a third-party application, such as a web browser or news reader, to take advantage of this connection. For information about third-party applications that support TCP/IP, check the web site <http://www.palm.com>.

To establish a connection:

- Tap Connect to dial the current service and display the Service Connection Progress messages.

Tip: To see expanded Service Connection Progress messages, press the lower half of the Scroll button.

To close a connection:

- Tap Disconnect to terminate the connection between your handheld and your service.

Creating additional service templates

You can create additional service templates from scratch or by duplicating existing templates and editing information. After you create a new or duplicate template, you can add and edit settings.

To add a new service template:

1. Tap the Menu icon .
2. Tap Service, and then tap New.
An Untitled service template is added to the Service pick list.

To duplicate an existing service template:

1. Tap the Service pick list.
2. Tap the predefined service template you want to duplicate.
3. Tap the Menu icon .
4. Tap Service, and then tap Duplicate.
A copy of the service template is added to the Service pick list.

Adding detailed information to a service template

If you are using one of the predefined service templates, you probably only need to enter your user name and telephone number. If you are creating a new service template, you may need to provide additional information to your ISP or dial-in server. You use the Details dialog box to add additional information to a selected service template.

To select a connection type:

1. Tap the service field.
2. Tap Details.

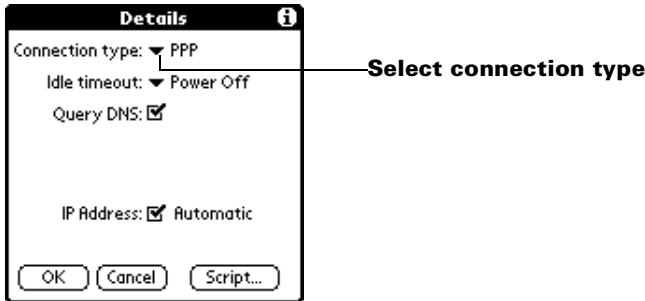

3. Tap the Connection type pick list and select one of the following connection types:

- | | |
|--------------|--|
| PPP | Point-to-Point protocol |
| SLIP | Serial Line Internet Protocol |
| CSLIP | Compressed Serial Line Internet Protocol |

Note: If you are not sure, try PPP; if that doesn't work, ask your Internet Service Provider or your System Administrator for the correct connection type.

Idle timeout

The Idle timeout setting defines how long your handheld waits before dropping the connection with your ISP or dial-in server when you switch out of a TCP/IP application.

To set the Idle timeout:

1. Tap the Idle timeout pick list and select one of the following options:
 - 1 minute** Waits one minute for you to open another application before it drops the connection.
 - 2 minutes** Waits two minutes.
 - 3 minutes** Waits three minutes.

Never Keeps your PPP or SLIP connection until you turn off your handheld (or until it times out). This option works best with the PalmModem accessory.

2. Tap OK.

Defining primary and secondary DNS

The Domain Naming System (DNS) is a mechanism in the Internet for translating the names of host computers into IP addresses. When you enter a DNS number (or IP address), you are identifying a specific server that handles the translation services.

Each IP address has four sections, separated by periods. In the Details dialog box, you enter each section separately. Each section of an IP address is made up of a number from 0 to 255; numbers are the only allowable characters in this field.

Ask your Internet Service Provider or System Administrator for the correct Primary or Secondary DNS IP numbers.

Tip: Many systems do not require that you enter a DNS. If you are not sure, leave the DNS field blank.

To enter a primary and secondary DNS:

1. Tap the Query DNS check box to deselect it.
2. Tap the space to the left of the first period in the Primary DNS field, and then enter the first section of the IP address.

Note: Each section must be a number from 0 to 255.

3. Repeat step 2 for the second, third, and last sections of the Primary DNS field.
4. Repeat steps 2 and 3 for the Secondary DNS number.
5. Tap OK.

IP address

Everyone who logs on to the Internet needs to have a unique identifier (an IP address), whether permanent or temporary. Some networks dynamically assign a temporary IP address when clients log in. The IP Address field lets you identify whether your network provides automatic (dynamic) temporary IP addressing.

Note: If your IP address is permanently assigned, you need to get that information from your System Administrator. If you are not sure, select Automatic.

To identify dynamic IP addressing:

- Tap the IP Address check box to select it.

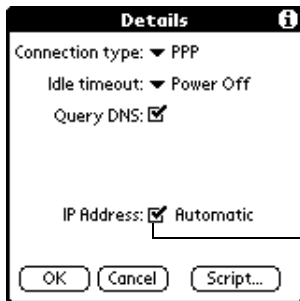

Tap to select automatic IP address

To enter a permanent IP address:

1. Tap the IP Address check box to deselect it and display a permanent IP address field below the check box.
2. Tap the space to the left of the first period then enter the first section of the IP address.

Note: Each section must be a number from 0 to 255.

3. Tap and enter the remaining sections of the IP address.
4. Tap OK.

Login scripts

A login script is a series of commands that automates logging into a network server, for example, your corporate network or your ISP. A login script is associated with a specific service template created in Network Preferences.

A login script is something that you are likely to receive from your IS System Administrator if your company has a system in which you log into the corporate servers from your handheld using a modem or network connection. The script is generally prepared by the System Administrator and distributed to users who need it. It automates the events that must take place in order to establish a connection between your handheld and the corporate servers.

You can create login scripts in two ways:

- In a text editor on your desktop computer, in which you create a file with the extension PNC, which you then install on your handheld using the Install Tool (this method is not available to Macintosh users)
- In the Login Script dialog box on your handheld, accessed from the Details dialog box in Network Preferences

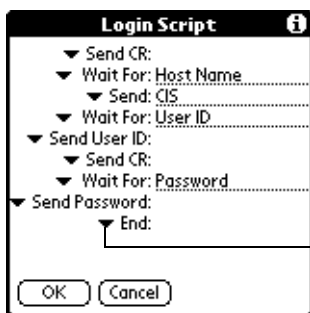

Tap here to see the list of available commands

Note: You can also use non-ASCII and literal characters in your login script. See Appendix C for more information.

Creating a login script on your handheld

You can create login scripts by selecting commands from the Command pick list in the Login Script dialog. Some commands, such as Send, require you to supply additional information. Those commands have a parameter field so that you can add the necessary data.

To create a login script:

1. Tap Script.
2. Tap the End pick list.

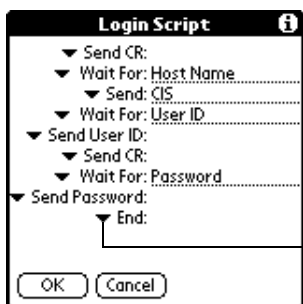

Tap here

3. Tap the command you want from the Command list. If the command requires additional information, a field appears to the right of it for you to enter the information. The following commands are available:

Wait For	Tells your handheld to wait for specific characters from the TCP/IP server before executing the next command.
Wait For Prompt	Detects a challenge-response prompt coming from the server and then displays the dynamically generated challenge value. You then enter the challenge value into your token card, which in turn generates a response value for you to enter on your handheld. This command takes two arguments, separated by a vertical bar () on the input line.
Send	Transmits specific characters to the TCP/IP server to which you are connecting.
Send CR	Transmits a carriage return or LF character to the TCP/IP server to which you are connecting.
Send User ID	Transmits the User ID information entered in the User ID field of the Network Preferences screen.
Send Password	Transmits the password entered in the Password field of the Network Preferences screen. If you did not enter a password, this command prompts you to enter one. The Password command is usually followed by a Send CR command.
Delay	Tells your handheld to wait a specific number of seconds before executing the next command in the login script.
Get IP	Reads an IP address and uses it as the IP address for your handheld. This command is used with SLIP connections.
Prompt	Opens a dialog box and prompts you to enter text of some kind (for example, a password or a security code).
End	Identifies the last line in the login script.

4. Repeat steps 2 and 3 until the login script is complete.
5. Tap OK.

Plug-in applications

You can create plug-in applications containing script commands that extend the functionality of the built-in script commands. A plug-in application is a standard PRC application that you install on your handheld just like any other application. After you install the plug-in application, you can use the new script commands in a login script.

Plug-in applications have the following characteristics:

- Written in C language
- Compiled into a device executable
- Called properly from a login script
- Able to return control to a login script after it terminates
- Created using a development environment that supports Palm OS software, such as Metrowerks CodeWarrior for Palm Platform.

For additional information on creating plug-in applications, send e-mail to Palm Developer Support at devsupp@palm.com.

Deleting a service template

There is only one way to delete a service template: use the Delete command from the Service menu.

To delete a service template:

1. Tap the Service pick list.
2. Tap the service template you want to delete.
3. Tap the Menu icon .
4. Tap Service, and then tap Delete.
5. Tap OK.

Network preferences menu commands

The Network Preferences screen includes menu commands to make it fast and easy to create and edit service templates. TCP/IP application menus are shown here for your reference. See “Using menus” in Chapter 1 for more information about choosing menu commands.

Service menu

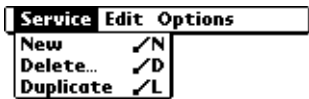

Options menu



TCP/IP troubleshooting

If you are having a problem establishing a network connection using TCP/IP, try the suggestions listed.

Displaying expanded Service Connection Progress messages

It's helpful to identify at what point in the login procedure the connection fails. An easy way to do this is to display the expanded Service Connection Progress messages. Expanded Service Connection Progress messages describe the current stage of the login procedure. Press the lower half of the scroll button at any point during login to display these messages.

Viewing the Network Log

If viewing the expanded Service Connection Progress messages does not give you enough information to find out why you cannot connect to your ISP or dial-in server, take a look at the Network Log. The Network Log lists all of the communication that occurs between your modem and your dial-in server during the login procedure. The information in the Network Log can help your ISP or your System Administrator pinpoint where the login procedure communication fails and why.

To view the Network Log:

1. Tap Options, and then tap View Log.
2. Tap the up and down arrows of the scroll bar to see the entire Network Log.
3. Tap Done.

Adding a DNS number

If your ISP or dial-in server requires a DNS number and you did not enter that information in the Network Preferences screen, it will appear that you successfully logged into your network. When you try to use an application or look up information, however, the connection fails. If this occurs, try adding a DNS number. Ask your ISP or your System Administrator for the correct Primary and Secondary DNS IP numbers.

Owner preferences

The Owner Preferences screen enables you to record a name, company name, phone number, or any other information that you want to associate with your handheld.

If you use the Security application to turn off and lock your handheld with a password, information that you put in the Owner Preferences displays the next time you turn on your handheld. See Chapter 1 for more information.

To enter the Owner preferences:

- Enter the text that you want to associate with your handheld in the Owner Preferences screen. If you enter more text than can fit on one screen, a scroll bar automatically appears on the right side of the screen.



The screenshot shows a window titled "Preferences" with a dropdown menu set to "Owner". The screen contains several text input fields with dotted lines for text entry:

- "This device is owned by:" followed by a dotted line.
- A field containing "Midyne Spear" followed by a dotted line.
- A field containing "Creative Spearit" followed by a dotted line.
- A field containing "Bonny Doon, CA" followed by a dotted line.
- A field containing "408-555-1212" followed by a dotted line.
- A field containing "If found, please contact me." followed by a dotted line.
- Two additional empty dotted lines for text entry.

If you assign a password with the Security application, the information in the Owner Preferences screen cannot be changed. In this case, an Unlock button appears at the bottom of the screen.

To unlock the Owner Preferences screen:

1. Tap Unlock.
2. Enter the password that you defined in the Security application.
3. Tap OK.

ShortCuts preferences

The ShortCuts Preferences screen enables you to define abbreviations for entering text with Graffiti strokes. This section describes how to create, edit, and delete a ShortCut. See Chapter 2 for more information on the use of ShortCuts.

Creating a ShortCut

You can create a ShortCut for any words, letters, or numbers. All ShortCuts you create appear on the list in the ShortCut Preferences screen. All the ShortCuts are available in any of your handheld applications and are backed up on your computer when you perform a HotSync operation.

To create a ShortCut:

1. Tap New.
2. On the ShortCut name line, enter the letters you want to use to activate the ShortCut.

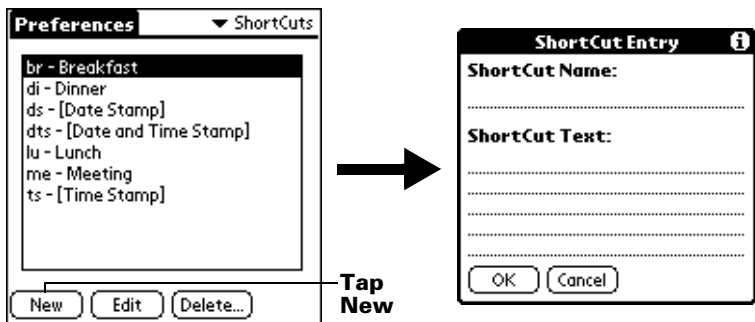

3. Tap the ShortCut Text area and enter the text that you want to appear when you write the ShortCut characters.

Tip: You may want to add a space (space character) after the last word in your ShortCut text. This way, a space automatically follows the ShortCut text.

4. Tap OK.

Tip: To use a ShortCut, draw the ShortCut stroke followed by the ShortCut characters. When you draw the ShortCut stroke, the ShortCut symbol appears at the insertion point to show that you are in ShortCut mode.



Editing a ShortCut

After you create a ShortCut, you can modify it at any time.

To edit a ShortCut:

1. Tap the ShortCut you want to edit.
2. Tap Edit.
3. Make the changes you want and tap OK.

Deleting a ShortCut

If you no longer need a ShortCut, you can delete it from the list of ShortCuts.

To delete a ShortCut:

1. Tap the ShortCut you want to delete.
2. Tap Delete.
3. Tap Yes.

Appendix A

Maintaining Your Handheld

This chapter provides information on the following:

- Proper care of your handheld
- Prolonging battery life
- Resetting your handheld

Caring for your handheld

Your handheld is designed to be rugged and reliable and to provide years of trouble-free service. Please observe the following general tips when using your handheld:

- Take care not to scratch the screen of your handheld. Keep the screen clean. When working with your handheld, use the supplied stylus or plastic-tipped pens intended for use with a touch-sensitive screen. Never use an actual pen or pencil or other sharp object on the surface of the handheld screen.
- Your handheld is not waterproof and should not be exposed to rain or moisture. Under extreme conditions, water may enter the circuitry through the front panel buttons. In general, treat your handheld as you would a pocket calculator or other small electronic instrument.
- Take care not to drop your handheld or subject it to any strong impact. Do not carry your handheld in your back pocket: if you sit on it, you may damage it.
- Protect your handheld from temperature extremes. For example, do not leave your organizer on the dashboard of a car on a hot day or on a day when temperatures are below freezing, and keep it away from heaters and other heat sources.
- Do not store or use your handheld in any location that is extremely dusty, damp, or wet.
- Use a soft, damp cloth to clean your handheld. If the surface of the handheld screen becomes soiled, clean it with a soft cloth moistened with a diluted window-cleaning solution.

Battery considerations

Please note the following considerations when replacing the batteries in your handheld:

- Under normal conditions, your handheld batteries should provide over one month of use. You can conserve battery life by minimizing the use of the backlight feature, and changing the Auto-off setting that automatically turns the handheld off after a period of inactivity. See “General preferences” in Chapter 7 for more information.
- If the batteries become low in the course of normal use, an alert appears on the handheld screen describing the low battery condition. If this alert appears, perform a HotSync[®] operation to back up your data before you replace the batteries. This helps prevent accidental data loss.
- When replacing the batteries, begin by turning your handheld off (so there is no screen display). Never remove the batteries while your handheld is turned on.
- When replacing the batteries, always use good quality batteries of the same type. Use only alkaline batteries with your handheld.
- When you remove the batteries, the built-in backup power of your handheld maintains memory data **for a period of up to one minute**. Whenever you remove the batteries, replace them immediately. If you encounter any difficulties in the course of battery replacement, reinstall the original batteries and wait a few minutes for the backup power to recharge.
- If the batteries drain to the point where your handheld does not operate, it stores your data safely for approximately two weeks. In this case, there is enough residual energy in the batteries to store the data, but not enough to turn on your handheld. If your handheld does not turn on when you press the power button, you should replace the batteries immediately.
- If you leave drained batteries in your handheld for an extended period of time, you can lose all of the stored data. If this happens, replace the batteries and use the reset button to reset your handheld. (See “Resetting your handheld” later in this chapter for details.) After you reset your handheld, perform a HotSync operation to restore the data from your computer.

Resetting your handheld

Under normal circumstances, you will not have to use the reset button. On rare occasions, however, your handheld may no longer respond to buttons or the screen. In this case, you need to perform a reset to get your handheld running again.

Performing a soft reset

A soft reset tells your handheld to stop what it's doing and start over again. All records and entries stored in your handheld are retained with a soft reset. After a soft reset, the Welcome screen appears, followed by the Date and Time Preferences screen (to set date and time).

To perform a soft reset:

- Use the tip of an unfolded paper clip (or similar object *without* a sharp tip), to gently press the reset button inside the hole on the back panel of your handheld.

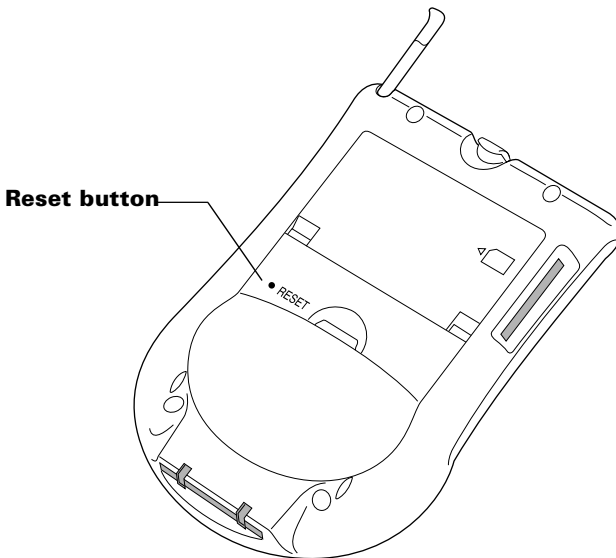

Performing a hard reset

With a hard reset, all records and entries stored in your handheld are erased. Never perform a hard reset unless a soft reset does not solve your problem.

Note: You can restore any data previously synchronized with your computer during the next HotSync operation.

To perform a hard reset:

1. Hold down the power button on the front panel of the handheld.
2. While holding down the power button, use the tip of an unfolded paper clip (or similar object *without* a sharp tip) to gently press and release the reset button.
3. Wait for the Palm™ logo to appear; then release the power button.
4. When a message appears on the handheld screen warning that you are about to erase all the data stored on your handheld, do one of the following:

Press the upper half of the scroll button on the front panel of the handheld to complete the hard reset and display the Digitizer screen.

Press any other button to perform a soft reset.

Note: With a hard reset, the current date and time are retained. Formats Preferences and other settings are restored to their factory default settings.

To restore your data from a Windows computer after a hard reset:

1. Click the HotSync icon ™ in the Windows system tray (bottom-right corner of the taskbar).

Tip: You can also click the HotSync command on the Palm™ Desktop software menu bar.

2. From the HotSync Manager menu, choose Custom.

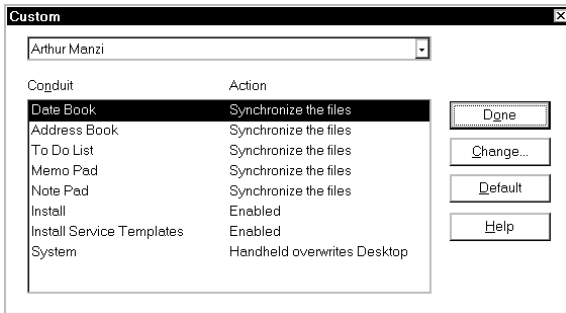

3. Select the appropriate user name from the list.
4. Select an application in the Conduit list.
5. Click Change.

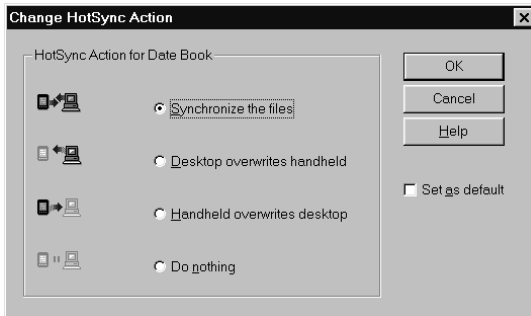

6. Select Desktop overwrites handheld.

Note: Changing the HotSync setting from the default affects only the *next* HotSync operation. Thereafter, the HotSync Actions revert to their default settings. To use a new setting on an ongoing basis, select the Set As Default box. Thereafter, whatever you selected as the default setting is used when you click the Default button in the Custom dialog.

7. Click OK.
8. Repeat steps 4 through 7 to change conduit settings for other applications.

9. Click Done to activate your settings.
10. Perform a HotSync operation.

To restore your data from a Macintosh after a hard reset:

1. Double-click the HotSync Manager in the Palm folder.
2. From the HotSync menu, choose Conduit Settings.

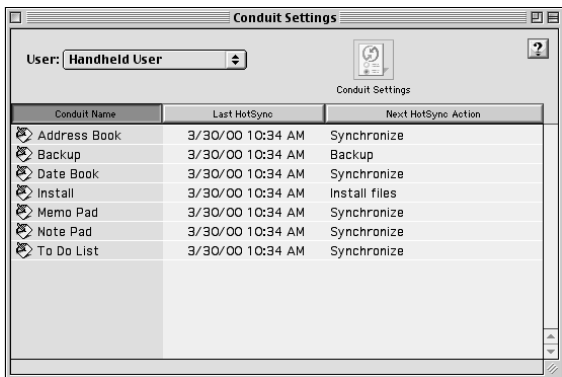

3. From the Users pop-up menu, select the appropriate user name.
4. Select an application from the list.
5. Click Conduit Settings.

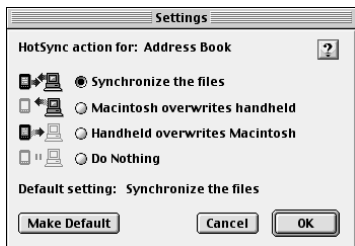

6. Click Macintosh overwrites handheld.

Note: Changing the HotSync setting from the default affects only the *next* HotSync operation. Thereafter, the HotSync Actions revert to their default settings. To use a new setting on an ongoing basis, click Make Default. Thereafter, whatever you selected as the default setting is used for HotSync operations.

7. Click OK.
8. Repeat steps 4 through 7 to change conduit settings for other applications.
9. Close the Conduit Settings window.
10. Perform a HotSync operation.

Appendix B

Frequently Asked Questions

If you encounter a problem with your handheld, do not call Technical Support until you have reviewed the following list of frequently asked questions, and you have also reviewed the following:

- The README file located in the folder where you installed the Palm™ Desktop software on your computer
- The Helpnote folder located in the folder where you installed the Palm Desktop software on your Windows computer (or on your Palm Desktop software CD-ROM)
- The Palm Desktop online Help
- The *Palm Desktop software for the Macintosh User's Guide* located in the Documentation folder in the Palm Desktop software folder
- The "Palm Support Assistant" knowledgebase, accessible at <http://www.palm.com> under the Support section
- The most recent Palm™ m100 series handheld HelpNotes on your regional web site

If you are still having problems, contact Technical Support. For US and International telephone numbers, go to <http://www.palm.com>.

Note: Thousands of third-party add-on applications have been written for the Palm OS® handhelds. Unfortunately, we are not able to support such a large number of third-party applications. *If you are having a problem with a third-party application, please contact the developer or publisher of that software.*

Software installation problems

Problem

The Palm Desktop Installer Menu did not appear when I inserted the CD-ROM into my Windows computer.

Solution

1. Click the Start button.
2. Choose Run from the Start menu.
3. Click Browse.
4. Locate your CD-ROM drive and select the Setup.exe file.
5. Click Open.
6. Click OK.

I cannot install Palm Desktop software on my Windows computer.

Try the following:

1. Disable any virus scanning software on your computer.
2. Press CTRL-ALT-DELETE and end all tasks except Systray and Explorer.

Note: If a dialog with buttons appears instead of a list of tasks, click the Task List button and then end all tasks except Systray and Explorer.

3. Make sure your computer has at least 30 MB of disk space available.
4. Delete all temporary files.
5. Run ScanDisk on your computer.
6. Reinstall Palm Desktop software.

I cannot install Palm Desktop software on a Macintosh.

Try the following:

1. Disable any virus scanning software on your Macintosh.
2. Quit any open applications.
3. Make sure your computer has at least 25 MB of disk space available.
4. Reinstall Palm Desktop software.

Operating problems

Problem

I don't see anything on my handheld's screen.

Solution

Try each of these in turn:

- Press an application button to ensure your handheld is turned on.
- Tap the Contrast icon  in the upper-right corner of the Graffiti® writing area. If the Contrast dialog box appears, adjust the contrast by holding down the up scroll button for a few seconds. If this doesn't work, hold the down scroll button for a few seconds.
- If your handheld was exposed to cold, make sure it is at room temperature.
- Make sure the batteries are fresh and properly installed.
- Perform a soft reset. If your handheld still doesn't turn on, perform a hard reset. See "Resetting your handheld" in Appendix A.

Important: With a hard reset, all records and entries stored in your handheld are erased. Never perform a hard reset unless a soft reset does not solve your problem. You can restore any data previously synchronized with your computer during the next HotSync® operation. See "Performing a hard reset" in Appendix A for instructions on restoring your data.

I get a warning message telling me my handheld memory is full.

- Purge records from Date Book and To Do List. This deletes To Do List items and past Date Book events from the memory of your handheld. See “Purging records” in Chapter 5. You may need to perform a HotSync operation to recover the memory.
- Delete unused memos and records. If necessary, you can save these records. See “Deleting records” in Chapter 5.
- If you have installed additional applications on your handheld, remove them to recover memory. See “Removing applications” in Chapter 3.

My handheld keeps turning itself off.

Your handheld is designed to turn itself off after a period of inactivity. This period can be set at one, two, or three minutes. Check the Auto-off setting. See “General preferences” in Chapter 7.

My handheld is not making any sounds.

Check the System, Alarm and Game Sound settings. See “General preferences” in Chapter 7.

My handheld has frozen.

Perform a soft reset. See “Resetting your handheld” in .

Tapping and writing problems

Problem

When I tap the buttons or screen icons, my handheld activates the wrong feature.

When I tap the Menu icon , nothing happens.

I can't get my handheld to recognize my handwriting.

Solution

Calibrate the screen. See "Digitizer preferences" in Chapter 7.

Not all applications or screens have menus. Try changing to a different application.

- For your handheld to recognize handwriting input with the stylus, you need to use Graffiti writing. See "Using Graffiti writing to enter data" in Chapter 2.
- Make the Graffiti character strokes in the Graffiti writing area, not on the display part of the screen.
- Write Graffiti strokes for letters in the left-hand side, and the strokes for numbers in the right-hand side of the Graffiti writing area.
- Make sure that Graffiti is not shifted into extended or punctuation modes. See "Using Graffiti writing to enter data" in Chapter 2.
- See "Graffiti tips" in Chapter 2 for tips on increasing your accuracy when you write Graffiti characters.

Application problems

Problem

I tapped the Today button, but it does not show the correct date.

I know I entered some records, but they do not appear in the application.

I am having problems listing memos the way I want to see them.

I created an event in Date Book, but it doesn't appear in the Week View.

I entered the euro symbol, but after a HotSync operation it doesn't appear in my Palm Desktop software.

Solution

Your handheld is not set to the current date. Make sure the Set Date box in the Date and Time Preferences screen displays the current date. See "Customizing your handheld" in Chapter 1 for more information.

- Check the Categories pick list (upper-right corner). Choose All to display all of the records for the application.
- Check Security and confirm that Private Records is set to Show private records.
- In To Do List, tap Show and see if Show Only Due Items is selected.
- If you cannot manually arrange the order of the memos in the list screen, check the Memo Preferences setting. Make sure that Sort by is set to Manual.
- If you choose to view your memos alphabetically on Palm Desktop software and then perform a HotSync operation, the memos on your handheld still appear in the order defined in the Memo Preferences setting. In other words, the sort settings you use with Palm Desktop software *are not* transferred to your handheld.

In the Week View, you cannot select overlapping events that have the same start time. If you have two or more events with the same start time, choose the Day View to see the overlapping events.

You must have fonts that include the euro symbol on your desktop computer. Check these web sites for additional information:
<http://www.microsoft.com/windows/euro.asp>
<http://til.info.apple.com/techinfo.nsf/artnum/n22222>

HotSync problems

Problem

I cannot do a HotSync operation; what should I check to make sure I am doing it correctly?

Solution

- Make sure the cradle/cable is connected securely.

On a Windows computer try these steps:

- Check the Windows system tray to make sure the HotSync Manager is running. If it is not, open Palm Desktop software.
- Make sure you selected Local USB or Local Serial, as appropriate, from the HotSync Manager menu.
- If you are using the optional serial cradle/cable, make sure you selected the correct serial port on the Local tab in the Setup dialog box. It should be set to the port where you connected the cradle/cable.

On a Macintosh try these steps:

- Make sure HotSync Manager is enabled. If it is not, double-click the HotSync Manager icon in the Palm folder and enable HotSync Manager on the HotSync Controls tab.
- If you are using the optional serial cradle/cable, double-click the HotSync Manager icon in the Palm folder and then click the Serial Port Settings tab. Make sure Local is selected and that the port selection matches the port where your cradle/cable is attached.

I did a HotSync operation, but one of my applications did not synchronize.

- On a Windows computer, click the HotSync Manager and choose Custom. Check that the correct conduit is active.
- On a Macintosh, double-click the HotSync Manager icon. From the HotSync menu, choose Conduit Settings. Select your user name from the User pop-up menu, and check that the correct conduit is active.

I am using Outlook as my PIM, but I cannot do a HotSync operation.

- Click the HotSync Manager and choose Custom. Check that the correct conduit is active.
- Check that the correct conduit is installed. Reinstall the HotSync Manager and make sure the correct conduit is selected.

I cannot launch the HotSync Manager.

- If you are using the optional serial cradle/cable, or if you are performing a HotSync operation using a modem, make sure you are not running another program, such as America Online, CompuServe, or WinFax, that uses the serial port you selected in the Setup dialog box.

I tried to do a local HotSync operation, but it did not complete successfully.

- Backup the Palm Desktop software, uninstall it, then reinstall it.
- If you are using a cradle, make sure your handheld is seated in the cradle correctly. If you are using a cable, make sure that it is connected securely to your handheld.
- Check the connection between the cradle/cable and the USB or serial port on your computer.
- Make sure the user name you selected in Palm Desktop software matches the user name assigned to your handheld.
- Make sure the date on your computer matches the date on your handheld.
- Read the HotSync Log for the user account for which you are performing a HotSync operation.

On a Windows computer, try each step in turn:

- Make sure HotSync Manager is running. If it is running, close it, and restart it.
- Make sure you selected Local USB or Local Serial, as appropriate, from the HotSync Manager menu.

I tried to do a local HotSync operation, but it did not complete successfully.
(continued)

- If you are using the optional serial cradle/cable, make sure you selected the correct serial port on the Local tab in the Setup dialog. It should be set to the port where you connected the cradle/cable.
- If you are using the optional serial cradle/cable, try a lower baud rate setting on the Local tab in the Setup dialog.
- If you are using the optional serial cradle/cable, make sure you aren't running a program, such as America Online, CompuServe, or WinFax, that uses the serial port you selected in the Setup dialog box.

On a Macintosh, try each step in turn:

- Make sure HotSync Manager is enabled on the HotSync Controls tab in the HotSync Software Setup window.
- If you are using the optional serial cradle/cable, make sure you selected Local on the Serial Port Settings tab in the HotSync software settings window, and that the Local Setup port matches the port where your cradle/cable is connected.
- If you are using the optional serial cradle/cable, try a lower Speed setting on the Serial Port Settings tab.
- If you are using the optional serial cradle/cable, make sure you aren't running a program, such as America Online, fax or telephony software, or AppleTalk networking that uses the serial port you selected in the Serial Port Settings tab.

I tried to do a modem HotSync operation, but it did not complete successfully.

Check the following on your computer:

- Make sure your computer is turned on and that it does not shut down automatically as part of an energy-saving feature.
- Make sure the modem connected to your computer is turned on and is connected to the outgoing phone line.
- Make sure the modem you are using with your handheld has an on-off switch. Your handheld cannot “wake up” a modem that has an auto-off feature.
- Make sure the modem is connected properly to your computer and is connected to the incoming phone line.

On a Windows computer, check the following:

- Make sure Modem is checked in the HotSync Manager menu.
- Confirm that the Setup String in the Setup dialog box configures your modem correctly. You may need to select a different Modem Type or enter a custom Setup String. Most modems have a Setup String that causes them to send initial connection sounds to a speaker. You can use these sounds to check the modem connection.
- Confirm that the Speed setting in the Setup dialog box works for your modem. If you have problems using the As Fast As Possible option or a specific speed, try using a slower speed.

I tried to do a modem HotSync operation, but it did not complete successfully. (continued)

- Make sure you are not running another program, such as WinFax, CompuServe, or America Online that uses the serial port you selected in the Setup dialog box.
- Make sure your modem resets before you try again. (Turn off your modem, wait a minute, then turn it back on.)

On a Macintosh, check the following:

- Make sure Modem is selected on the Serial Port Settings tab in the HotSync Software Setup window.
- You may need to select a different Modem type or enter a Custom setup string on the Serial Port Settings tab. Most modems have a setup string that causes them to send initial connection sounds to a speaker. You can turn on the Modem Speaker option and use these sounds to check the modem connection.
- Make sure you are not running another program, such as America Online, fax or telephony software, or AppleTalk networking that uses the serial port you selected in the Serial Port Settings tab.
- Make sure your modem resets before you try again. (Turn off your modem, wait a minute, then turn it back on.)

Check the following on your handheld:

- Confirm that the telephone cable is securely attached to your modem.
- Make sure the dialing instruction dials the correct phone number.
- If you need to dial an outside line prefix, make sure you selected the Dial Prefix option on your handheld and entered the correct code.

I tried to do a modem HotSync operation, but it did not complete successfully.
(continued)

- If the telephone line you are using has Call Waiting, make sure you selected the Disable call waiting option under Modem Sync Phone Setup on your handheld and entered the correct code.
- Make sure the telephone line you are using is not noisy, which can interrupt communications.
- Check the batteries in your modem and replace them if necessary.

I can't perform an IR HotSync operation.

- On a Windows computer, be sure the HotSync Manager is running and the Serial Port for local operations is set to the simulated port for infrared communication. See "IR HotSync operations" in Chapter 6 for details.
- On a Macintosh, open the HotSync Software Setup window and be sure HotSync Manager is enabled and that the Local Setup Port is set to Infrared Port. See "IR HotSync operations" in Chapter 6 for more information.
- On your handheld, be sure the HotSync application is set to Local, with the option IR to PC/Handheld.
- Be sure the IR port of your handheld is aligned directly opposite to, and within a few inches of, the infrared device of your computer.
- IR HotSync operations do not work after you receive a low battery warning. Check the batteries in your handheld and replace them if necessary.

My handheld appears to freeze when I place it near my computer.

Move your handheld away from the computer's infrared port.

When I press the HotSync button on the cradle/cable, nothing happens on the Palm Desktop software, and my handheld times out.

When I perform a HotSync operation, my information does not transfer to Palm Desktop software.

My handheld displays the message "Waiting for sender" when it's near my computer's infrared port.

- Make a copy of your Palm folder. Uninstall, then reinstall Palm Desktop software.
- Turn on your handheld and tap the Applications icon. Tap the HotSync icon, then tap Local.
- If you have performed a HotSync operation successfully, but you cannot find the data from your handheld on Palm Desktop software, check to see you have the correct user name selected for viewing data.
- On a Windows computer, click the HotSync Manager and choose Custom. Check that all conduits are set to synchronize files.
- On a Macintosh, double-click the HotSync Manager icon. From the HotSync menu, choose Conduit Settings. Select your user name from the User pop-up menu, and check that the correct conduit is active.
- Your computer's infrared port may be set to search automatically for the presence of other infrared devices. Consult the documentation for your operating system for information about turning off this option.
- In some cases, simply moving your handheld away from the computer's infrared port solves the problem.

I want to synchronize my computer with more than one handheld.

- If the computer running Palm Desktop software synchronizes with more than one handheld, each handheld must have a unique name. Assign a user name to your handheld the first time you perform a HotSync operation.
- Please be aware that synchronizing more than one handheld with the same user name causes unpredictable results and, potentially, loss of your personal information.

Beaming problems

Problem

I cannot beam data to another Palm OS handheld.

When someone beams data to my handheld, I get a message telling me it is out of memory.

Solution

- Confirm that your handheld and the other Palm OS handheld are between ten centimeters (approximately 4") and one meter (approximately 39") apart, and that the path between the two handhelds is clear of obstacles. Beaming distance to other Palm OS handhelds may be different.
- Move your handheld closer to the receiving handheld.
- Your handheld requires at least twice the amount of memory available as the data you are receiving. For example, if you are receiving a 30K application, you must have at least 60K free.
- Perform a soft reset. See "Performing a soft reset" in Appendix A for more information.

Password problems

Problem

I forgot the password, and my handheld is not locked.

Solution

- First, use the password hint to try and remember the password. If this does not help, or if you do not have a password hint, you can use Security to delete the password, but your handheld deletes all entries marked as private. However, if you perform a HotSync operation *before* you delete the password: the HotSync process backs up all entries, whether or not they are marked private. Then, you can follow these steps to restore your private entries:

1. Use the Palm Desktop software and the cradle/cable or infrared communication to synchronize your data.
2. Tap Forgotten Password in Security to remove the password and delete all private records.
3. Perform a HotSync operation to synchronize your data and restore the private records by transferring them from your computer to your handheld.

I forgot the password and my handheld is locked.

- First, use the password hint to try and remember the password. If this does not help, or if you do not have a password hint, you must perform a hard reset to continue using your handheld. See “Performing a hard reset” in Appendix A for more information.



Technical support

If, after reviewing the sources listed at the beginning of this appendix, you cannot solve your problem, contact your regional technical support office by e-mail, phone, or fax.

Before requesting support, please experiment a bit to reproduce and isolate the problem. When you do contact support, please be ready to provide the following information:

- The name and version of the operating system you are using
- The actual error message or state you are experiencing
- The steps you take to reproduce the problem
- The version of handheld software you are using and available memory

To find version and memory information:

1. Tap the Applications icon .
2. Tap the Menu icon .
3. Tap App, and then tap Info.

Note: Thousands of third-party add-on applications have been written for the Palm OS handhelds. Unfortunately, we are not able to support such a large number of third-party applications. *If you are having a problem with a third-party application, please contact the developer or publisher of that software.*

4. Tap Version to see version numbers, and tap Size to see the amount of free memory in kilobytes.

Appendix C

Non-ASCII Characters for Login Scripts

The following information enables you to create custom login scripts that require non-ASCII characters. It is provided for advanced users who understand the use and requirements of such characters in a custom login script.

Use of ^char

You may use the caret (^) to transmit ASCII command characters. If you send ^*char*, and the ASCII value of *char* is between @ and _, then the character is automatically translated to a single-byte value between 0 and 31.

For example, ^M is converted to a carriage return. If *char* is a value between a and z, then the character sequence is translated to a single-byte value between 1 and 26. If *char* is any other value, then the character sequence is not subject to any special processing.

For example, the string “Joe^M” transmits Joe, followed by a carriage return.

Carriage return and line feed

You may include carriage return and line feed commands as part of the login script, when entered in the following format:

- <cr>Sends or receives a carriage return
- <lf>Sends or receives a line feed

For example, the string “waitfor Joe<cr><lf>” waits to receive Joe followed by a carriage return and line feed from the remote computer before executing the next command in the script.

Literal characters

The backslash (\) character defines that the *next character* is transmitted as a literal character, and is not subject to any special processing ordinarily associated with that character.

Examples:

- `\^` Includes a caret as part of the string
- `\<` Includes a `<` as part of the string
- `\\` Includes a backslash as part of the string

Product Regulatory Information

FCC Statement

This device complies with part 15 of the FCC rules. Operation is subject to the following two conditions: (1) This device may not cause harmful interference, and (2) this device must accept any interference received, including interference that may cause undesired operation.

Note: This equipment has been tested and found to comply with the limits for a Class B digital device, pursuant to Part 15 of the FCC rules. These limits are designed to provide reasonable protection against harmful interference in a residential installation. This equipment generates, uses, and can radiate radio frequency energy and, if not installed and used in accordance with the instructions, may cause harmful interference to radio communications. However, there is no guarantee that interference will not occur in a particular installation. If this equipment does cause harmful interference to radio or television reception, which can be determined by turning the equipment off and on, the user is encouraged to try to correct the interference by one or more of the following measures:

- Reorient or relocate the receiving antenna.
- Increase the separation between the equipment and receiver.
- Connect the equipment into an outlet on a circuit different from that to which the receiver is connected.
- Consult the dealer or an experienced radio/TV technician for help.

The use of shielded I/O cables is required when connecting this equipment to any and all optional peripheral or host devices. Failure to do so may violate FCC rules.

Caution: Changes or modifications not covered in this manual must be approved in writing by the manufacturer's Regulatory Engineering Department. Changes or modifications made without written approval may void the user's authority to operate this equipment.

Responsible Party:

Palm, Inc.
5470 Great America Parkway
Santa Clara, California 95052
United States of America
(408) 326-9000



Canadian ICES-003 Statement

This Class B digital apparatus meets all requirements of the Canadian Interference-Causing Equipment Regulations.

Cet appareil numérique de la classe B respecte toutes les exigences du Règlement sur le matériel brouilleur du Canada.



CE Compliance Statement

This product was tested by Palm, Inc. and found to comply with all the requirements of the EMC Directive 89/336/EEC as amended.



This is a Class B product based on the standard of the Voluntary Control Council for Interference from Information Technology Equipment (VCCI). If this is used near a radio or television receiver in a domestic environment, it may cause radio interference. Install and use the equipment according to the instruction manual.

この装置は、情報処理装置等電波障害自主規制協議会（VCCI）の基準に基づくクラスB情報技術装置です。この装置は、家庭環境で使用することを目的としていますが、この装置がラジオやテレビジョン受信機に近接して使用されると、受信障害を引き起こすことがあります。

取扱説明書に従って正しい取り扱いをして下さい。

Battery Warning

Do not mutilate, puncture, or dispose of batteries in fire. The batteries can burst or explode, releasing hazardous chemicals. Discard used batteries according to the manufacturer's instructions and in accordance with your local regulations.

Warning

Eksplotionsfara vid felaktigt batteribyte. Använd samma batterityp eller en ekvivalent typ som rekommenderas av apparattillverkaren. Kassera använt batteri enligt fabrikan- tens instruktion.

Advarsel!

Lithiumbatteri—Eksplotionsfare ved fejlagtig håndtering. Udskiftning må kun ske med batteri af samme fabrikat og type. Levér det brugte batteri tilbage tilleverandøren.

Varoitus

Paristo voi räjähtää, jos se on virheellisesti asennettu. Vaihda paristo ainoastaan valmistajan suosittelemaan tyyppiin. Hävitä käytetty paristo valmistajan ohjeiden mukaisesti.

Advarsel

Ekspløsjonsfare ved feilaktig skifte av batteri. Benytt samme batteritype eller en tilsvarende type anbefalt av apparatfabrikanten. Brukte batterier kasseres i henhold til fabrikantens instruksjoner.

Waarschuwing!

Bij dit produkt zijn batterijen geleverd. Wanneer deze leeg zijn, moet u ze niet weggegooiden maar inleveren als KCA.

Uwaga

Nie kroić lub przekłuwać baterii, ani nie wrzucać ich do ognia. Mogą się rozerwać lub wybuchnąć wydzielając trujące środki chemiczne. Zużytych baterii należy pozbywać się w sposób opisany przez producenta i zgodnie z miejscowymi przepisami.

Nowe baterie powinny być tego samego lub analogicznego typu, co baterie zalecane w instrukcji obsługi kieszonkowego komputera Philips. Regeneracyjne baterie litowe mogą wybuchnąć jeżeli nie są odpowiednio umieszczone w komputerze.

אזהרה

יש סכנת התפוצצות אם מחליפים את הסוללה בצורה לא נכונה.
יש להחליף את הסוללה בסוללה זהה או דומה, בהתאם להמלצת היצרן.
יש להשליך סוללות משומשות בהתאם להוראות היצרן

Index

A

- ABA (Address Book archive file) 39
- Accented characters
 - Graffiti writing 35
 - onscreen keyboard 38
- Add-on applications 46–51
- Address Book
 - *If Found Call* entry 115
 - adding custom fields 118
 - archive files (.aba) 39
 - business card for beaming 83
 - categorizing records 85
 - conduit for synchronizing 141
 - creating records 72, 113–115
 - deleting records 75
 - displaying category 118
 - displaying data in the Address list 116
 - finding records 88–89
 - fonts 96
 - menus 117
 - notes for records 96
 - opening 69
 - overview 68
 - private records 95
 - sorting records 92
- Agenda (Date Book view) 110
- Alarm
 - lists 98
 - preset 113
 - setting in Clock 132
 - setting in Date Book 103
 - setting in Note Pad 125
 - sound 113, 134, 163, 194
- Alphabet
 - Graffiti writing 32
 - onscreen keyboard 17, 23
- Application buttons 6, 19
 - for cycling through views 68, 69, 70, 71
 - reassigning 158

Applications

- Address Book 68
 - beaming 82–84
 - Calculator 71
 - categories 43–44
 - Clock 72
 - Date Book 67
 - font style 97
 - installing 46–50
 - Launcher 19, 43–45
 - Memo Pad 71
 - Note Pad 70
 - opening 19
 - plug-in 178
 - preferences for 45
 - removing 50
 - security 52
 - size in kilobytes 207
 - To Do List 69
 - version of 207
 - viewing as icons 44
 - viewing as list 44
 - See also* Add-on applications
- ## Archive files
- importing data from 39
 - for main applications 39
 - saving deleted records 75
 - saving purged records 76
- ## Auto-off delay 162
- ## Autotext. *See* Graffiti ShortCuts

B

- Backlight 5, 159
- Batteries
 - battery door 7
 - conserving power 162
 - gauge 19
 - installing 11
 - life and use 184
 - warning 212–213
- Beaming
 - information 82–84
 - location of IR port 7
 - pen stroke to activate 160
 - problems with 205
 - See also* Infrared

- Bold font for text 96
 - Business card for beaming 83
 - Buttons preferences 158
- C**
- Cable
 - connecting to computer 8
 - for local HotSync operations 147
 - Calculator
 - buttons explained 130–131
 - memory 130
 - opening 72
 - overview 71
 - recent calculations 71, 131
 - Calibration 16, 161, 195
 - Call Waiting, disabling 152, 170
 - Calling card, using in phone settings 152, 171
 - Capital letters (Graffiti writing) 33
 - Card. *See* Expansion Card
 - Caring for the handheld 183
 - Categories
 - application 43–44
 - assigning records to 84–85
 - beaming 82–83
 - creating 86–87
 - default 85
 - displaying 86, 118, 196
 - merging 88
 - renaming 87
 - using in Applications Launcher 44
 - Chain calculations 131
 - Characters, Graffiti 29
 - Check boxes 18
 - Clearing Calculator entries 130
 - Clearing notes 74
 - Clock
 - alarm 132
 - alarm preferences 134
 - display options 134
 - menus 133
 - opening 72, 132
 - Combining categories 88
 - Comma delimited files, importing data from 39
 - Command
 - buttons 18
 - equivalents (Graffiti writing) 21
 - toolbar 21
 - Command stroke 21, 84, 91
 - Compressing Day view 112
 - Computer keyboard, entering data with 25
 - Conduits
 - for connecting to PIMs 16
 - for modem HotSync operations 152
 - for synchronizing applications 197, 141–142, 188
 - for synchronizing applications, Macintosh 142–143
 - Conflicting events 109
 - Connecting
 - service templates 172
 - to server or ISP 171
 - Connection
 - preferences 166
 - selecting for network 168
 - Continuous events
 - deleting from Date Book 76
 - scheduling 104
 - Contrast control 17
 - Copying
 - notes into other applications 70
 - text 74
 - Country default setting 161
 - Cradle
 - connecting to computer 8
 - for local HotSync operations 78, 147
 - Creating
 - Address Book entries 113–115
 - categories 43–44, 86–87
 - custom fields in Address Book 118
 - Date Book events 99
 - memos 128
 - notes for records 96
 - records 72
 - To Do List items 119
 - Current date 196

Current time 19
 displaying in Date Book 107
 setting 27
Custom fields, in Address Book 118
Customizing. *See* Preferences
Cutting text 74
Cycling through views 68, 69, 70, 71

D

Data entry. *See* Entering data
Date
 displaying in Clock 134
 setting current 27, 196
 To Do List record due 121
Date and Time preferences 26
Date Book
 adding Address Book data to
 records 90–91
 Agenda view 110
 alarm 103
 archive files (.dba) 39
 changing event time 103
 changing event to untimed 102
 conduit for synchronizing 141
 conflicting events 109
 continuous events 104–106
 creating records 72, 99–103
 Day view 107
 deleting records 75
 display options 112
 displaying current time 107
 end time for Day view 113
 fonts 96
 menus 111
 Month view 109
 notes for records 96
 opening 68
 overview 67
 private records 95
 purging records 76
 repeating events 76, 104–106
 scheduling events 99–103
 selecting dates 101
 start time for Day view 113
 Sunday or Monday to start week
 162

 switching views 107
 untimed events 99, 102
 Week view 107, 162, 196
Day
 displaying in Clock 134
 in Date Book view 99, 112
DBA (Date Book archive file) 39
Decimal point 162
Default
 categories 85
 settings. *See* Preferences
Deleted data, saving in archive files
75
Deleting
 applications 46, 50
 Desktop software 51
 Graffiti characters 31
 passwords 53
 records 75
 service templates 178
 text 74
 See also Purging records
Desktop software 12–14
 for entering data 25
 linking to external files 153
 removing 51, 52
 saving deleted data to an archive
 file 75
 system requirements 4
 upgrading 8
 See also PIM
Digitizer 16, 161, 195
DNS (Domain Naming System) 174
Double-booked events 109
Dragging
 memos into other applications
 71
 stylus to activate features 159
 using the stylus 17

E

Editing records 73–75
E-mail addresses
 in Address Book 115, 116
Entering data 22–25
 importing from other

- applications 39–41
- problems with 195
- using Graffiti writing 29–37
- using Note Pad 38
- using the computer keyboard 39
- using the onscreen keyboard 38

Entries. *See* Address Book

Euro

- in Graffiti writing 35
- in onscreen keyboard 23
- problems with 196

Events. *See* Date Book

Exchanging data. *See* HotSync

Exclamation marks in To Do List 122

Expansion

- adding hardware 8, 59
- using cards 59–65

Expansion Card

- applications 60
- copying applications 61
- deleting applications 62
- formatting 64
- inserting 59
- removing 60
- renaming 64

External keyboard 26

F

Face plate 5, 6

- changing 10

FAQ 191–206

FCC Statement 211

Files, linking to external 153

Finding

- applications, using Graffiti writing 19
- information in applications 88–91
- phone numbers 90–91
- using the Find application 89

Fonts 96, 97

Formats preferences 161

Frequently asked questions 191–206

Frozen handheld 194

G

Games 163

General preferences

- alarm sounds 163
- auto-off delay 162
- system sounds 163

Glossary. *See* Graffiti ShortCuts

Graffiti

- accented characters 35
- alphabet 29, 32
- basic concepts 29
- capital letters 33
- Command stroke 21
- defined 24
- Giraffe game for practicing 24
- how to write characters 30
- menu commands 21
- moving the cursor 36
- numbers 33
- online Help 75, 159
- problems using 195
- punctuation marks 34
- ShortCuts for entering data 37, 181–182
- symbols 35
- tips 31
- writing 29–37
- writing area 5, 30

H

handheld

- battery door 7
- battery installation 11

Hard reset 186, 193

Hardware add-ons 8, 59

Help

- Graffiti 75
- online tips 22

Hiding records 93

HotSync

- buttons preferences 160
- conduits for synchronizing applications 141–142, 188
- conduits for synchronizing applications,

- Macintosh 142–143
 - customizing 141, 142
 - defined 77
 - first-time operation 77–82, 154–156
 - HotSync Manager 77
 - IR operation 143–147
 - linking to external files 153
 - local operation 78, 136, 198, 199
 - local operation on Macintosh 81
 - modem operation 137, 148–153, 200–202
 - modem settings 149
 - operations using cradle/cable 147, 164
 - operations using IR port 144–146, 165–166
 - problems with 197–203
 - problems with IR 202
 - restoring data 186–189
 - setting options 135–137
 - for synchronizing data 12
 - using with another PIM 51
- I**
- Icons
 - alarm 103
 - application 17, 44
 - note 96
 - online Tips 22
 - onscreen 195
 - repeating event 105
 - Idle timeout of ISP or server connection 173
 - Importing data 25, 39–41
 - Infrared
 - connections 164
 - HotSync operations 144–146, 165–166
 - port 7, 143
 - problems with IR HotSync operations 202
 - requirements for computer 144
 - Initialization string 166
 - Installing
 - applications 46–50
 - batteries 11
 - conduit to install applications 141
 - Desktop software 14
 - International characters
 - Graffiti writing 35
 - onscreen keyboard 38
 - IP address 172, 174
 - IR port 7, 144
 - See also* Beaming and Infrared
 - IR. *See* Infrared
 - IrCOMM 143, 164
 - IrDA (Infrared Data Association) 143
 - Items. *See* To Do List
- K**
- Keyboard
 - computer 39
 - external 26
 - onscreen 17, 38, 159
- L**
- Letters
 - font style 97
 - Graffiti 29, 32
 - onscreen keyboard 38
 - List, in Applications Launcher 44
 - Locking the handheld with a password 54–57, 160, 180
 - Login scripts 175–178, 209
 - Looking up Address Book data
 - to add to other records 90–91
 - scrolling in Address list 89
 - Lost
 - handheld, contact for 115
 - records 196
 - Lotus Organizer, importing data from 39
- M**
- Macintosh 176
 - Macintosh computer
 - user profiles for 155
 - Maintenance information 183

Masking records 93
Memo Pad
 adding Address Book data to records 90–91
 archive files (.mpa) 39
 categorizing records 84
 conduit for synchronizing 141
 creating records 72, 128
 deleting records 75, 105
 dragging memos into other applications 71
 fonts 96
 menus 129, 131
 opening 71
 overview 71
 private records 95
 reviewing memos 128
 sorting records 92, 196
Memory
 amount of free 207
 for beaming 205
 Calculator 130
 regaining 76, 194
Memos. *See* Memo Pad
Menus 20–22, 195
 Address Book 117
 choosing 21
 command equivalents (Graffiti writing) 21
 command toolbar 22
 Date Book 111, 133
 Edit menu 74–75
 Memo Pad 127, 129, 131
 menu bar 17, 20
 Network Preferences 178
 Note Pad 127
 To Do List 123
Microsoft Outlook, connecting to 16, 198
MMC card 3
 See also Expansion Card
Modem
 HotSync operations via 148–153, 200–202
 initialization string 166
Monday, to start week 162
Month (Date Book view) 109, 112

Moving the cursor (Graffiti writing) 36
MPA (Memo Pad archive file) 39
MultiMediaCard 3
 See also Expansion Card

N

Network
 connecting 172
 connection type 173
 idle timeout 173
 login scripts 175–178
 password 168
 phone settings 169
 preferences 166–180
 primary DNS 174
 secondary DNS 174
 selecting connection 168
 selecting service 167
 TCP/IP 166
 user name 167
Note Pad
 alarm 125
 clearing notes 74, 125
 conduit for synchronizing 141
 copying notes into other applications 70
 entering data 38
 menus 127
 opening 70
 overview 70
 private records 95
 reviewing notes 124
Notes, attaching to records 96
Numbers
 decimal point and thousands separator 162
 Graffiti writing 33
 onscreen keyboard 17, 38

O
Onscreen keyboard 23, 38, 75
 pen stroke to open 159
Opening
 Address Book 69

- applications 19–20
- Calculator 72
- Clock 72, 132
- Date Book 68
- Memo Pad 71
- Note Pad 70
- To Do List 70
- Organizer (Lotus PIM) 39
- Outlook, connecting to 16, 198
- Overlapping events 109
- Owner preferences 180

P

- Palm Desktop software. *See* Desktop software
- Passwords 52–57
 - changing 53
 - creating 52
 - deleting 53
 - for network 168
 - forgotten 57, 206
- Pasting
 - notes into other applications 70
 - text 74
- Pen stroke, full-screen 159–160
- Peripheral hardware 8, 59
- Personal information managers. *See* PIM
- Phone
 - Phone Lookup 90–91
 - selecting phone numbers for
 - Address list 116
 - selecting types of phone numbers 115
 - settings for ISP or dial-in server 169–171
- Pick lists 18
- PIM (personal information manager)
 - using HotSync Manager with 51
 - using with handheld 16
 - See also* Desktop software
- Plug-in applications 178
- port 150
- Ports, IR on handheld 143
- Power button 5
- PPP 172
- PQA (query application file extension) 46
- PRC (application file extension) 46, 178
- Preferences 26
 - Buttons 158
 - choosing 45
 - Connection 166
 - Date and Time 26
 - Digitizer 161
 - Formats 161
 - General 162
 - HotSync buttons 160
 - Network 166–180
 - Owner 180
 - ShortCuts 181
- Primary DNS 174
- Printing records from applications 13
- Prioritizing To Do List records 119, 123
- Private records
 - displaying and creating 93–95, 196
 - lost with forgotten password 57
 - See also* Security
- Profiles 153
- Punctuation marks
 - Graffiti writing 34
 - onscreen keyboard 38
- Purging
 - records 76
 - See also* Deleting

R

- Range of times in Day view 113
- Receiving data. *See* Beaming information
- Records
 - Address Book 113
 - beaming 82–83
 - choosing categories 84
 - creating 72
 - Date Book 99
 - defined 72
 - deleting 75, 105
 - displaying a category of 86

- editing 73–75
- fonts 96
- hiding private 52, 93
- lost 196
- masking private 52, 93
- Memo Pad 128
- notes for 96
- number of 207
- private 93–95
- purging 76
- sorting 91–93
- To Do List 119
- unmasking individual 95

Reminder lists 98

Removing

- applications 50
- Desktop software 51

Renaming categories 87

Repeating events

- deleting from Date Book 76
- scheduling 104

Rescheduling events 103

Resetting handheld

- hard reset 186, 193
- location of reset button 7, 185
- soft reset 185

Restoring data

- from a Macintosh 188–189
- from a Windows computer 186–188

S

Saving data 43, 73, 75

Scheduling events 99–103

Screen

- backlight 5
- blank 193
- calibrating 16, 161
- caring for 183
- touching with your finger 5

Scroll

- bar 18
- buttons 6

SD card 3

- See also* Expansion Card

Searching. *See* Finding

Secondary DNS 174

Secure Digital card 3

- See also* Expansion Card

Security 52–57

- changing password 53
- deleting password 53
- displaying owner's name 180
- forgotten password 57
- private records 93–95
- setting a password hint 53
- unmasking individual records 95

Selecting

- date for event 101
- phone numbers in Address Book 115
- text 74, 75

Sending data. *See* Beaming information

Serial port 137, 139, 140, 148, 150

Service

- selecting for network 167
- templates 172, 178

Settings. *See* Preferences

ShortCuts

- backing up 141
- managing 181–182
- menu commands 21
- predefined 37
- using 37

Soft reset 185

Sorting

- applications 44
- records 91–93, 196

Sounds. *See* Alarm and System sounds

Starting applications 19–20

Stylus

- dragging with 17
- pen stroke to activate a feature 159
- tapping with 16
- writing with 7, 29

Sunday, to start week 162

Symbols, in Graffiti writing 35

Synchronizing data. *See* HotSync

System

- conduit 141
- requirements for Desktop
 - software 4
- sounds 163

T

- Tab delimited files, importing data from 39
- Tapping 16, 195
- TCP/IP 166, 179
- TDA (To Do List archive file) 39
- Technical Support 191, 207
- Text
 - copying 74
 - cutting 74
 - entry. *See* Entering data
 - files, importing data from 39, 40
 - fonts for 96
 - selecting all 75
- Thousands separator 162
- Time
 - alarm setting 103
 - format 162
 - setting current 27
 - setting event 99
 - start and end for Date Book Day
 - view 113
- Tips, online 22
- To Do List
 - adding Address Book data to
 - records 90–91
 - archive files (.tda) 39
 - categorizing records 84, 123
 - checking off items 120
 - completed items 122
 - completion date 122
 - conduit for synchronizing 141
 - creating records 72, 119
 - deleting records 75, 105
 - due date 121, 122
 - fonts 96
 - menus 123
 - notes for records 96
 - opening 70
 - overview 69

- prioritizing records 119, 123
- private records 95
- purging records 76, 122
- sorting records 92

- Today. *See* Current date
- Transferring data. *See* HotSync
- Transmitting data. *See* Beaming information
- Troubleshooting 191–206
- Turning off handheld
 - automatically 162
 - pen stroke for 160
 - problems with 194
- Turning on handheld
 - application buttons 6
 - displaying owner's name 180
 - power button 5
 - problems with 193

U

- Undoing actions 74
- Uninstalling Desktop software 51
- Universal connector 8, 59, 164
- Unresponsive handheld 194
- Untimed events 99, 102, 104
- Updating data. *See* HotSync
- User name
 - for ISP 167
 - identifying handheld 180
- User profiles 154
 - HotSync operation with 156

V

- VCal 39
- VCard 39

W

- Web sites 16
- Week (Date Book view) 107–108, 162, 196
- Writing area 5
- Writing. *See* Entering data

